

Haier®

TFT-LCD TV/DVD Combo OWNER'S MANUAL

Please READ this manual carefully before operating your TV, and retain it for future reference.

Haier

Haier

MODELS:

HLC32R1

HLC26R1

Haier

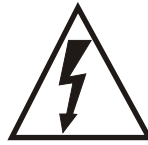

The lightning flash with arrowhead symbol, within an equilateral triangle is intended to alert the user to the presence of uninsulated dangerous voltage within the product's enclosure that may be of sufficient magnitude to constitute a risk of electric shock.



The exclamation point within an equilateral triangle is intended to alert the user to the presence of important operating and maintenance (servicing) instructions in the literature accompanying the appliance.

WARNING: TO PREVENT FIRE OR SHOCK HAZARD, DO NOT EXPOSE THIS APPLIANCE TO RAIN OR MOISTURE.

CAUTION: TO PREVENT ELECTRIC SHOCK DO NOT USE THIS POLARIZED PLUG WITH AN EXTENSION CORD, RECEPTACLE OR OTHER OUTLET UNLESS THE BLADES CAN BE FULLY INSERTED TO PREVENT BLADE EXPOSURE.

CAUTION: These servicing instructions are for use by qualified service personnel only. To reduce the risk of electric shock, do not perform any servicing other than that contained in the operating instructions unless you are qualified to do so.

Important Safety Instructions

- 1) Read these instructions.
- 2) Keep these instructions.
- 3) Heed all warnings.
- 4) Follow all instructions.
- 5) Do not use this apparatus near water.
- 6) Clean only with dry cloth.
- 7) Do not block any ventilation openings. Install in accordance with the manufacturer's instructions.
- 8) Do not install near any heat sources such as radiators, heat registers, stoves, or other apparatus (including amplifiers) that produce heat.
- 9) Do not defeat the safety purpose of the polarized or grounding-type plug. A polarized plug has two blades with one wider than the other. A grounding type plug has two blades and a third grounding prong. The wide blade or the third prong are provided for your safety. If the provided plug does not fit into your outlet, consult an electrician for replacement of the obsolete outlet.
- 10) Protect the power cord from being walked on or pinched particularly at plugs, convenience receptacles, and the point where they exit from the apparatus.
- 11) Only use attachments/accessories specified by the manufacturer.
- 12) Use only with the cart, stand, tripod, bracket, or table specified by the manufacturer, or sold with the apparatus. When a cart is used, use caution when moving the cart/ Apparatus combination to avoid injury from tip-over.
- 13) Unplug this apparatus during lightning storms or when unused for long periods of time.
- 14) Refer all servicing to qualified service personnel. Servicing is required when the apparatus has been damaged in any way, such as power-supply cord or plug is damaged, liquid has been spilled or objects have fallen into the apparatus, the apparatus has been exposed to rain or moisture, does not operate normally, or has been dropped.
- 15) The apparatus shall not be exposed to dripping or splashing and that no objects filled with liquids, such as vases, shall be placed on the apparatus.
- 16) The mains plug or appliance inlet is used as the disconnect device, remain it readily operable during the apparatus normal use.



Class I apparatus shall be connected to a mains socket outlet with a protective earthing connection.

Class I apparatus shall be connected to a mains socket outlet with a protective earthing connection.

LASER SAFETY: This unit employs a laser. Only a qualified service person should remove the cover or attempt to service this device, due to possible eye injury.

CAUTION: USE OF ANY CONTROLS, ADJUSTMENTS, OR PROCEDURES OTHER THAN THOSE SPECIFIED HEREIN MAY RESULT IN HAZARDOUS RADIATION EXPOSURE.

CAUTION: VISIBLE AND INVISIBLE LASER RADIATION WHEN OPEN AND INTERLOCK DEFEATED. DO NOT STARE INTO BEAM.

LOCATION: INSIDE, NEAR THE DECK MECHANISM.

FCC STATEMENT

This equipment has been tested and found to comply with the limits for a Class B digital device, pursuant to Part 15 of the FCC Rule. These limits are designed to provide reasonable protection against harmful interference in a residential installation. This equipment generates, use and can radiate radio frequency energy and, if not installed and used in accordance with the instructions, may cause harmful interference to radio communications. However there is no guarantee that interference will not occur in particular installation. If this equipment does cause harmful interference to radio or television reception, which can be determined by turning the equipment off and on, the user is encourage to try to correct the interference by one or more of the following measures:

- *Reorient or relocate the receiving antenna.
- *Increase the separation between the equipment and receiver.
- *Connect the equipment into an outlet on a circuit different from that to which the receiver is connected.
- *Consult the dealer or an experienced radio/TV technician for help.

This device compiles with Part 15 of the FCC Rules. Operation is subject to the following two conditions:

- (1) This device may be not cause harmful interference.
- (2) this device must accept any interference received, including interference that may cause undesired operation.

FCC CAUTION:

To assure continued compliance and possible undesirable interference, the provided ferrite cores must be used when connecting this LCD display to video equipment; and maintain at least 40cm spacing to other peripheral device.

CANADIAN NOTICE:

This Class B digital apparatus compiles with Canadian ICES-003.



Energy Star compliant

By being Energy Star compliant you are assured that your Haier model is helping the environment by using less energy while saving you money. ENERGY STAR is a joint program of the U.S. Environmental Protection Agency and the U.S. Department of Energy promoting energy efficiency.

SAVE THESE INSTRUCTIONS

Thank you for purchasing the Haier product. This easy-to-use manual will guide you in getting the best use of your product. Remember to record the model and serial number. They are on label in back of the unit.

Model number

serial number

Date of purchase

Staple your receipt to your manual. **You will need it to obtain warranty service.**

Contents

Warning	2	Video Menu	
Safety Instructions	3	How to select picture mode	21
Introduction		How to customize your own picture status	21
Controls	6	VGA Set	22
Connection Options	7	Audio Menu	
Universal Remote control	8	How to select audio mode	23
Installation		How to customize your own audio status	23
Accessories	9	SAP Broadcasts Setup	23
Antenna Connection	9	Function Menu	
Connecting a VCR	10	Menu Language	24
External A/V Source Setup	11	OSD Timeout	24
Connecting a DVD player	11	OSD Transparency	24
Connecting a DTV (digital TV)	12	Screen Mode	24
Connecting digital audio output	12	Blue Screen	25
Connecting a computer	13	DPMS	25
Monitor Out Setup	14	Time zone setting	25
HDMI and DVI input	14	Date /Time setting	25
Cable sample	15	Sleep Timer setting	26
Connecting Headphones	16	DTV Caption Style	26
Power source	16	Lock Menu	
Removing the tablestand and installing a wall mount bracket	17	Parental Control rating and categories	27
Operation		Lock setup	28
Switching On/Off the TV set	18	Other Functions	
Choose the Menu Language	18	Brief Info	30
Choose the input source	18	Using the Guide	30
Channel Menu		Quick program view	31
Channel Scan	19	CC (Closed Caption Display)	31
Channel Skip	19	USB Input	32
Select the desired program	20	DVD Operation	
Select the desired sound	20	Basic Playback	34
Mute	20	Advanced Playback	34
		Special Function Playback	35
		DVD System Setup	35
		Playable Discs	36
		Discs Protection and DVD Characteristics	37
		Maintenance	38
		Product Specification	39
		Troubleshooting	40
		Warranty	41

Controls

This is a simplified representation of the TV front panel, side panel control buttons and side inputs.

TV Side panel controls and connections

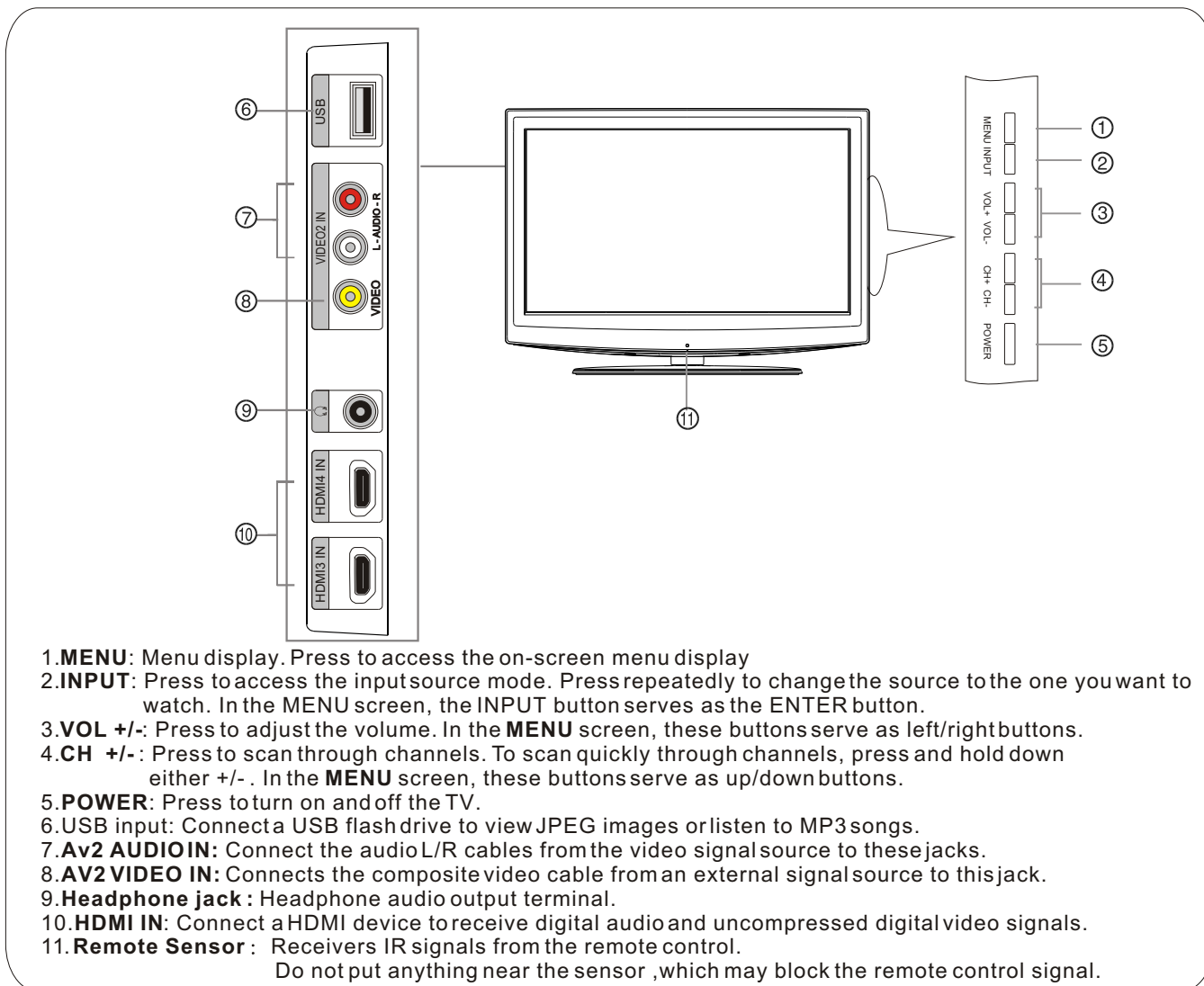

DVD panel controls

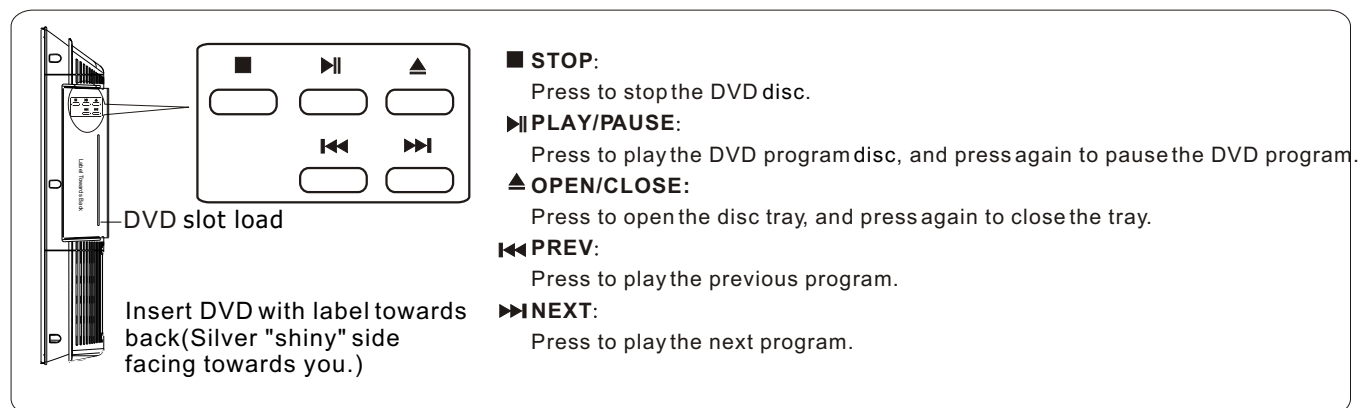

Connection Options

Back panel connections

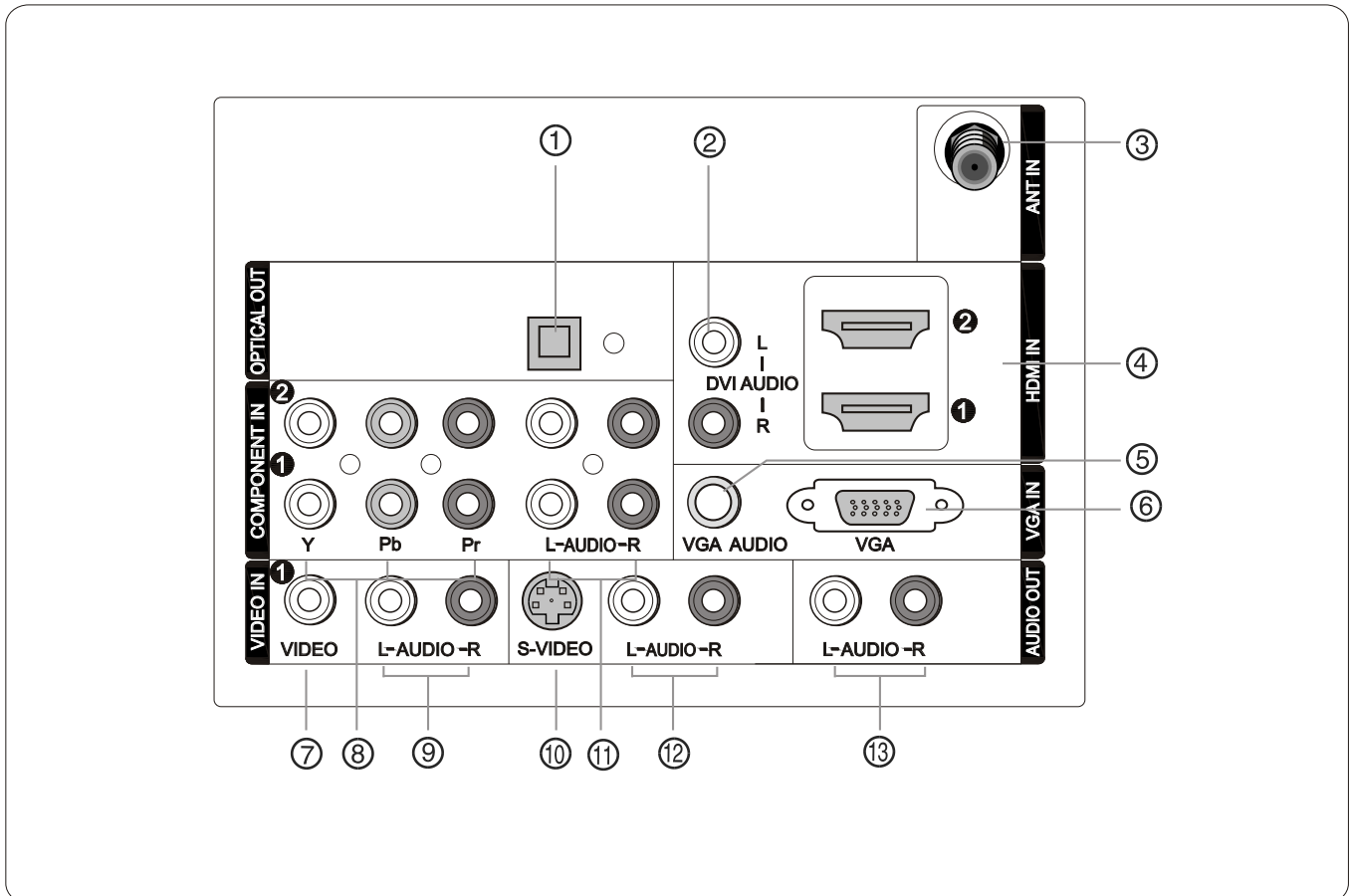

1. **Digital Audio Output:** Connect various types of digital audio equipment.
NOTE: In standby mode, these ports will not work.
2. **DVI Audio In:** When using a DVI to HDMI adapter, connect the audio signal to these jacks.
3. **Antenna Input:** Connect cable or antenna signals to the TV, either directly or through your cable box.
4. **HDMI In:** Connect a HDMI device to receive digital audio and uncompressed digital video.
5. **VGA Audio In:** Connect the audio L/R cables from a computer to this jack.
6. **VGA Video In:** Connect a video cable from a computer to this jack.
7. **VIDEO In:** Connects the video signal from a video device.
8. **Component Video In:** Connect a component video device to these jacks.
9. **AUDIO In:** Connect the audio L/R cables from the video signal source to these jacks.
10. **S-VIDEO In:** Connect the S-Video cable from an external signal source to this jacks.
11. **COMPONENT AUDIO In:** Connect the audio L/R cables from the component video signal source to these jacks.
12. **AUDIO In:** Connect the audio L/R cables from the S-Video signal source to these jacks.
13. **AUDIO Out:** Connect the audio L/R cables to your audio equipment.

Remote control

The remote control cannot be operated unless the batteries are properly loaded. When using the remote control, aim it at the remote sensor on the TV.

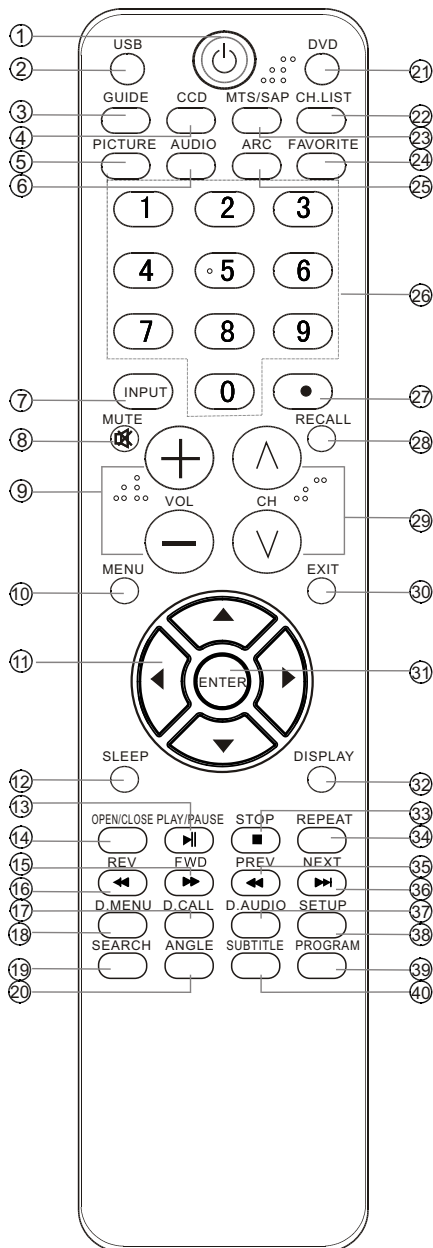

1. **Power** Press to turn on and off the TV.
2. **USB** Press to switch input source to USB in.
3. **GUIDE** Display the guide when you are watching analog or digital channels.
4. **CCD(closed caption)** Select a closed caption option
5. **PICTURE** Press repeatedly to cycle through the available picture modes.
6. **AUDIO**
Press to cycle through different sound settings.
7. **INPUT** Show the input source.
8. **MUTE** Switches the sound on or off.
9. **VOLUME UP/DOWN** Press to adjust the volume.
10. **MENU** Press to open the on-screen menu
11. **Thumbstick(Up/Down/Left/Right)**
Allows you to navigate the on-screen menus and adjust the system settings to your preference.
12. **SLEEP button** Press to display the sleep timer option.
13. **DVD PLAY/PAUSE**
14. **DVD Open/close**
15. **DVD FAST FORWARD**
16. **DVD FAST REVERSE**
17. **DVD CALL**
18. **DVD MENU**
19. **DVD SEARCH**
20. **DVD ANGLE**
21. **DVD Mode**
22. **CH.LIST** Open the channel list in TV.
23. **MTS/SAP** Select MONO, STEREO, SAP in NTSC system
24. **FAVORITE** Open the favourite channel list in TV
25. **ARC** Select the aspect ratio
26. **Number buttons** Press to change a channel.
27. **• button** Press to select digital channels. For example, to enter "54-3", press "54", "•" and "3".
28. **RECALL** Press to jump back and forth between two channels.
29. **CHANNEL UP/DOWN** Press to scan between the last two channels, press and hold down either +/- .
30. **EXIT** Clears all on-screen displays and returns to TV viewing from any menu.
31. **ENTER** Accesses the highlighted item in the on-screen menu
32. **DISPLAY**
Press to display the TV status information on the top of the TV screen.
33. **DVD STOP**
34. **DVD REPEAT**
35. **DVD Previous Chapter**
36. **DVD Next Chapter**
37. **DVD AUDIO Mode**
38. **DVD SETUP**
39. **DVD PROGRAM**
40. **DVD SUBTITLE**

External Equipment Connections

Accessories

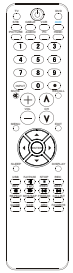

Remote control

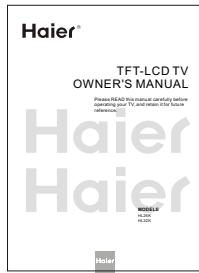

Owner`s manual

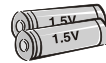

Alkaline battery(AAA)×2

Antenna Connection

Over-the-air TV reception quality will depend on your antenna type, antenna location and antenna positioning.

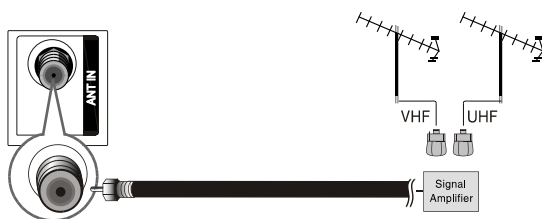
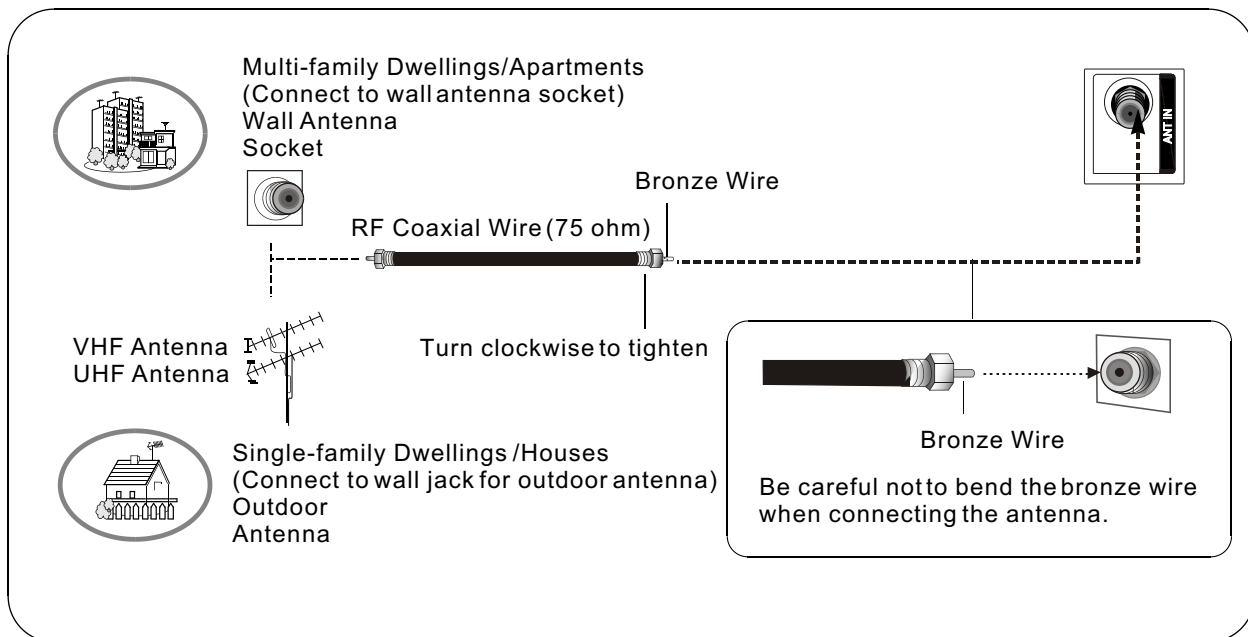

- To improve the picture quality in a poor signal area, please purchase a signal amplifier and install properly.
- If the antenna needs to be split for two TV`s, install a "2-Way Signal Splitter" in the connections.
- To install the antenna properly please contact a professional in your area.

External Equipment Connections

NOTE: All cables shown are not included with the TV.

Choose Your Connection

There are several ways to connect your television, depending on the components you want to connect and the quality of the signal you want to achieve. The following are examples of some different ways to connect your TV with different input sources.

Connecting a VCR

To avoid picture noise (interference), leave an adequate distance between the VCR and TV.

Connection Option 1

Set VCR output switch to channel 3 or 4 and then tune the TV to the same channel number.

Connection Option 2

1. Connect the audio and videocables from the VCR's output jacks to the TV input jacks, as shown in the figure. When connecting the TV to VCR, match the jack colors (Video = yellow, Audio Left = white, and Audio Right = red). If you connect a S-VIDEO output from VCR to the S-VIDEO input, the picture quality is improved; compared to connecting a regular VCR to the Video input.

2. Insert a video tape into the VCR and press PLAY on the VCR. (Refer to the VCR owner's manual.)

3. Select the input source with using the INPUT button on the remote control, and then press ▲ / ▼ button to select the source, press ENTER button to confirm.

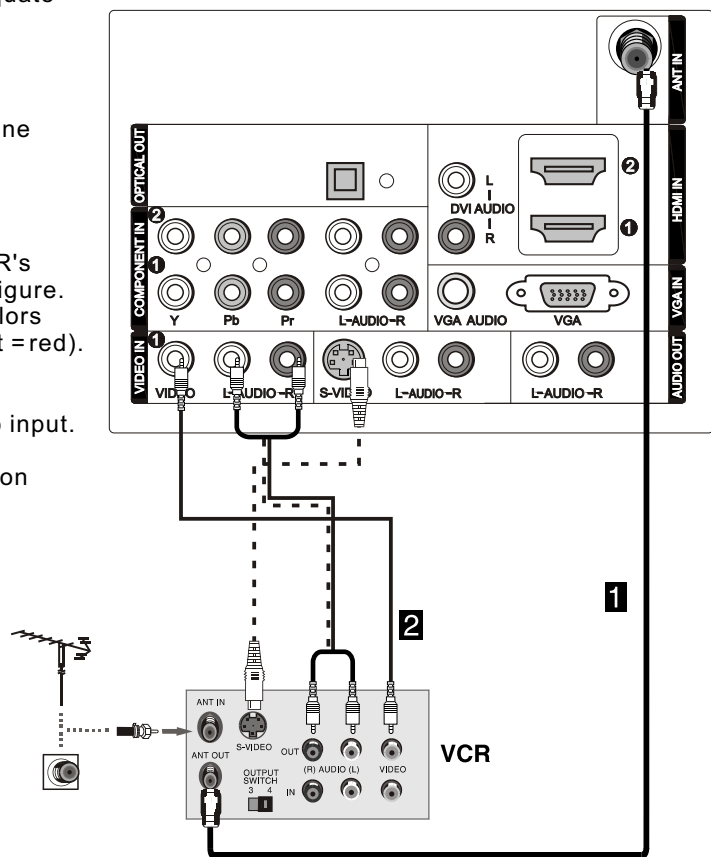

External Equipment Connections

External A/V Source Setup

How to connect

Connect the audio and video cables from the external equipment's output jacks to the TV input jacks, as shown in the figure.

When connecting the TV to external equipment, match the jack colors (Video = yellow, Audio Left = white, and Audio Right = red).

How to use

1. Select the input source with using the INPUT button on the remote control.
2. Press ▲/▼ button to select the desired source.
3. Press ENTER button to confirm.
4. Operate the corresponding external equipment.

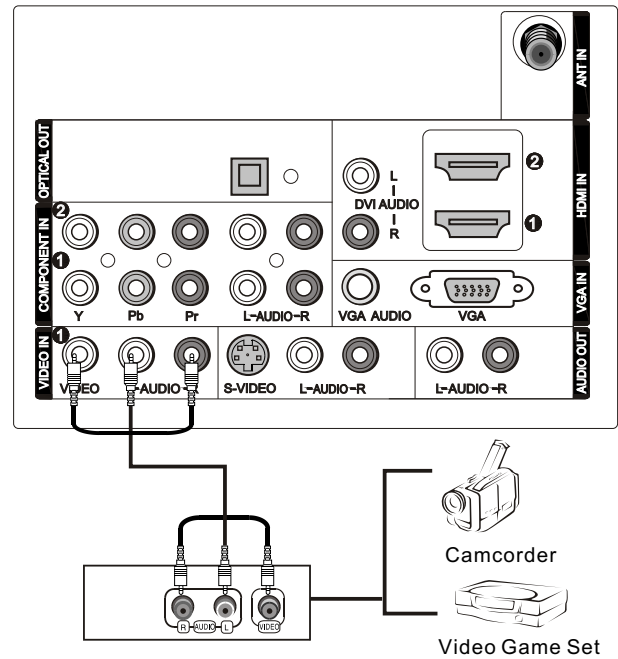

Connecting a DVD player

How to connect

1. Connect the DVD video outputs (COMPONENT) to the YPbPr jacks on the TV and connect the DVD audio outputs to the YPbPr Audio IN jacks on the TV, as shown in the figure.
2. If your DVD only has an S-VIDEO output jack, connect this to the S-VIDEO input on the TV, as shown in the figure.

Note

If your DVD player does not have component video output, use S-Video.

How to use

1. Turn on the DVD player, insert a DVD.
2. Use INPUT button on the remote control to select component mode.
3. Press Play button on external equipment for program play.
4. Refer to the DVD player's manual for operating instructions.

■ Component Input ports

To get better picture quality, connect a DVD player to the component input ports as shown below.

Component ports on the TV	Y	Pb	Pr
Video output ports on DVD player	Y	Pb	Pr
	Y	B-Y	R-Y
	Y	CB	CR
		P _B	P _R

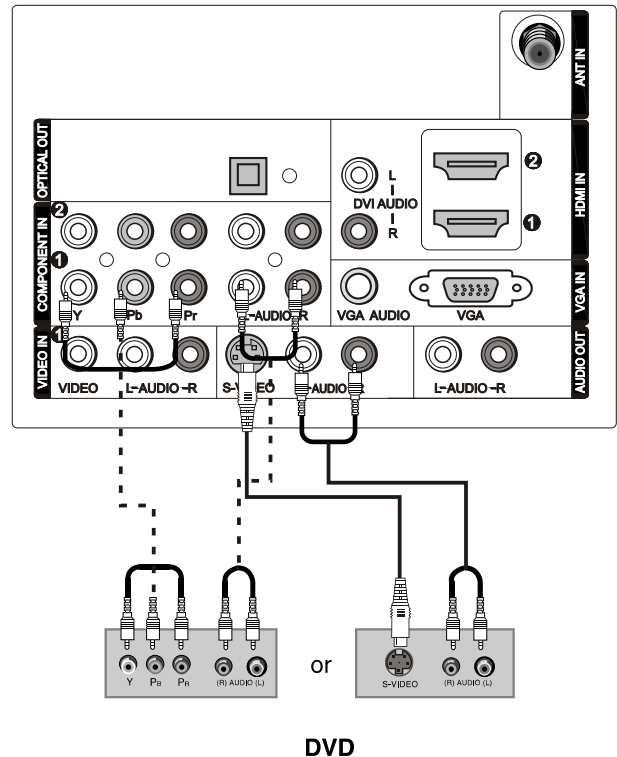

External Equipment Connections

Connecting a DTV(digital TV)

This TV can receive Digital Over-the-air/Cable signals without an external digital set-top box. However, if you do receive Digital signals from a digital set-top box or other digital external device, refer to the figure as shown below. This TV supports HDCP (High-bandwidth Digital Contents Protection) protocol for Digital Contents (480p, 720p, 1080i).

How to connect

Use the TV's COMPONENT, VGA or HDMI jack for video connections, depending on your set-top box connector. Then, make the corresponding audio connections.

How to use

1. Turn on the digital set-top box. (Refer to the owner's manual for the digital set-top box.)
2. Use INPUT on the remote control to select COMPONENT, VGA or HDMI source.

Signal	COMPONENT	HDMI
480i	Yes	Yes
480p	Yes	Yes
720p	Yes	Yes
1080i	Yes	Yes
1080p	Yes	Yes

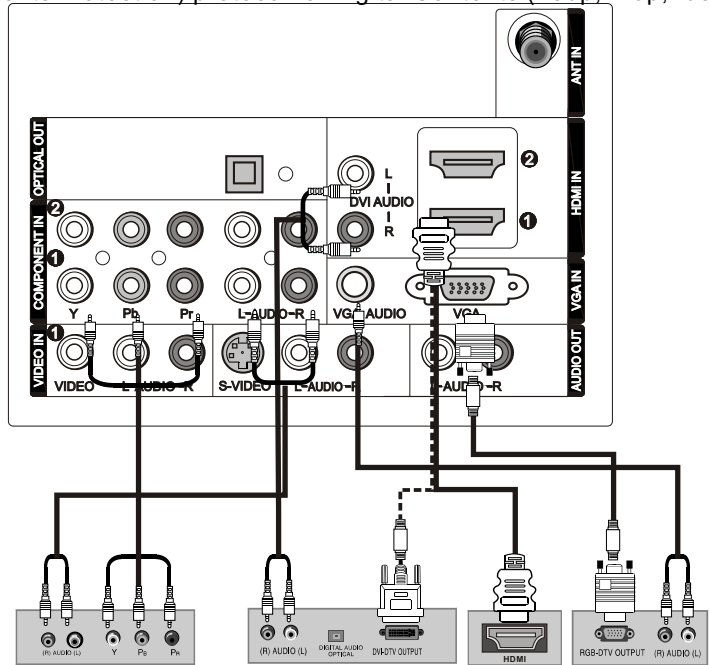

Digital Set-top Box

Connecting a digital audio output

Send the TV's audio to external audio equipment (stereo system) via the Digital Audio Output (Optical) port.

How to connect

1. Connect one end of an optical cable to the TV Digital Audio(Optical) Output port.
2. Connect the other end of the optical cable to the digital audio (optical) input on the audio equipment. See the external audio equipment instruction manual for operation.

Note

When connecting with external audio equipments, such as amplifiers or speakers, please turn the TV speakers off.

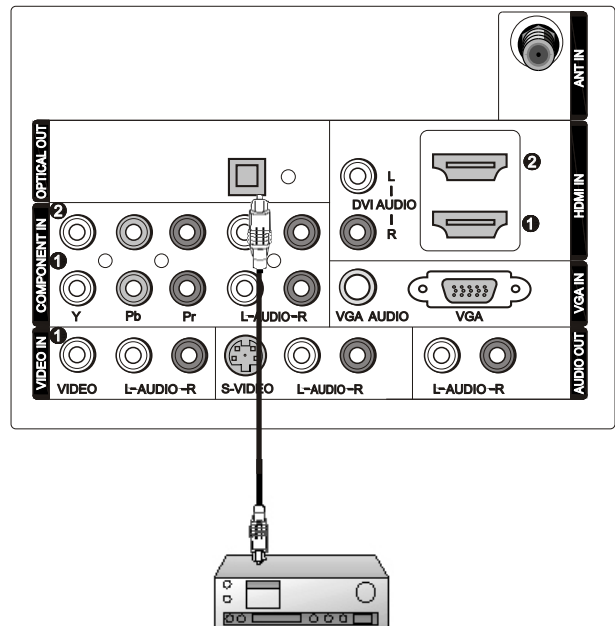

Caution: Do not look into the optical output port. Looking at the laser beam may damage your vision.

External Equipment Connections

Connecting a computer

How to connect

1. To get the best picture quality, adjust the VGA graphics card to 1024x768.
2. Use the TV's VGA or DVI (Digital Visual Interface) Audio IN port for audio connections, depending on your computer connector.
 - If the graphic card on the computer does not output analog and digital RGB simultaneously, connect only one of either VGA IN or HDMI IN to display the VGA on the TV.
 - If the graphic card on the computer does output analog and digital RGB simultaneously, set the TV to either VGA or HDMI; (the other mode is set to Plug and Play automatically by the TV.)
3. Then, make the corresponding audio connection. If using a sound card, adjust the VGA sound as required.

How to use

1. Turn on the computer and the TV.
2. Use INPUT on the remote control to select VGA or HDMI source.
3. Check the image on your TV. There may be noise associated with the resolution, vertical pattern, contrast or brightness in VGA mode. If noise is present, change the VGA mode to another resolution, change the refresh rate to another rate or adjust the brightness and contrast on the menu until the picture is clear. If the refresh rate of the VGA graphic card can not be changed, change the VGA graphic card or consult the manufacturer of the VGA graphic card.

Note

1. Use a DVI cable.
2. Avoid keeping a fixed image on the TV's screen for a long period of time. The fixed image may become permanently imprinted on the screen.
3. The synchronization input form for Horizontal and Vertical frequencies is separate.

Resolution

Mode	Resolution	Frame frequency (Hz)
VGA	640x480	60Hz
SVGA	800x600	60Hz
		75Hz
XGA	1024x768	60Hz
		75Hz

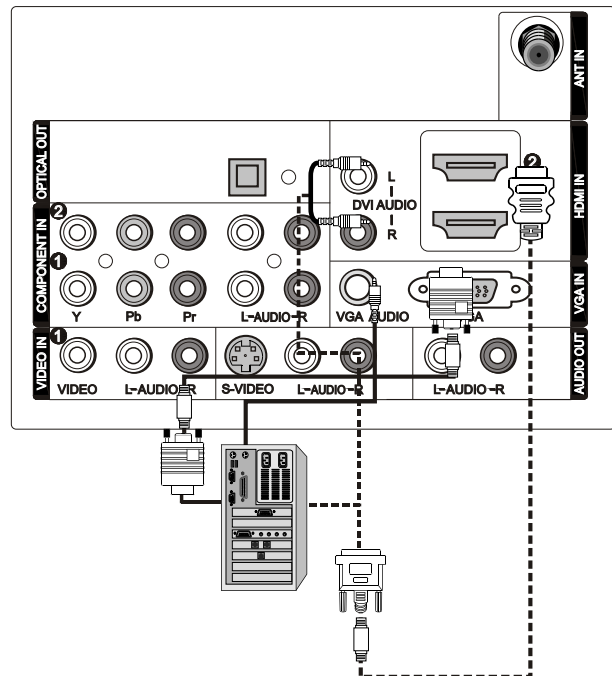

External Equipment Connections

HDMI and DVI input

When the source device(DVD player or Set Top Box) supports HDMI

How To Connect

1. Connect the source device to HDMI port of this TV with an HDMI cable(not supplied with this product).
2. No separated audio connection is necessary.

How To Use

If the source device supports Auto HDMI function, the output resolution of the source device will be automatically set to 1280x720p.

If the source device does not support Auto HDMI, you need to set the output resolution appropriately.

To get the best picture quality, adjust the output resolution of the source device to 1280x720p.

Select HDMI input source in input source option of Select Main source menu.

When the source device(DVD player or Set Top Box) supports DVI

How To Connect

1. Connect the source device to HDMI port of this TV with a HDMI-to-DVI cable(not supplied with this product).
2. A separated audio connection is necessary.
3. If the source device has an analog audio output connector, connect the source device audio output to DVI Audio In port located on the left side of HDMI port.

How To Use

If the source device supports Auto DVI function, the output resolution of the source device will be automatically set to 1280x720p.

If the source device does not support Auto DVI, you need to set the output resolution appropriately.

To get the best picture quality, adjust the output resolution of the source device to 1280x720p.

Press the INPUT button to select HDMI input source in input source option of Select Main source menu.

Cable sample

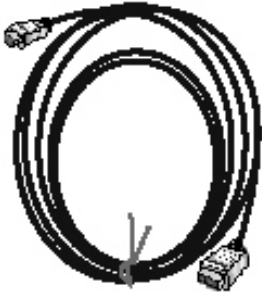

HDMI Cable
(not supplied with the product)

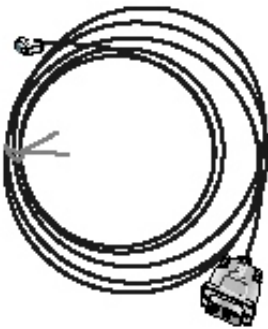

HDMI to DVI Cable
(not supplied with the product)

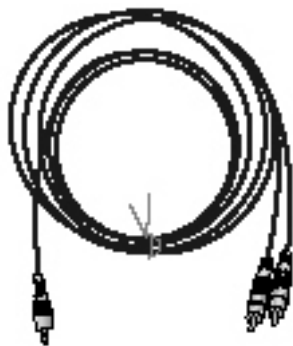

Analog Audio Cable
(Stereo to RCA type)
(not supplied with the product)

External Equipment Connections

Connecting Headphones

You can connect a set of headphones to your set if you wish to watch a TV programme without disturbing the other people in the room.

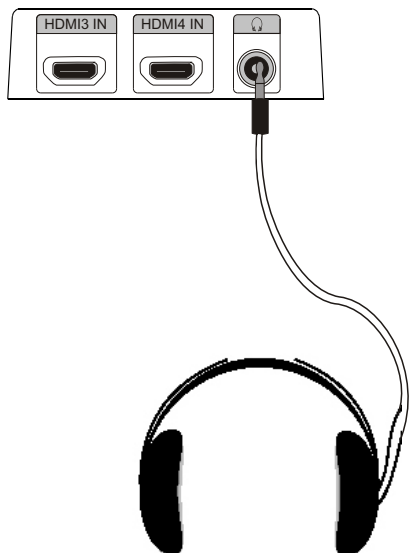

Plug a set of headphones into the 3.5mm mini-jack socket on the side panel of the set.

Note

- Prolonged use of headphones at a high volume may damage your hearing.
- You will not receive sound from the speakers when you connect headphones to the system.

Power source

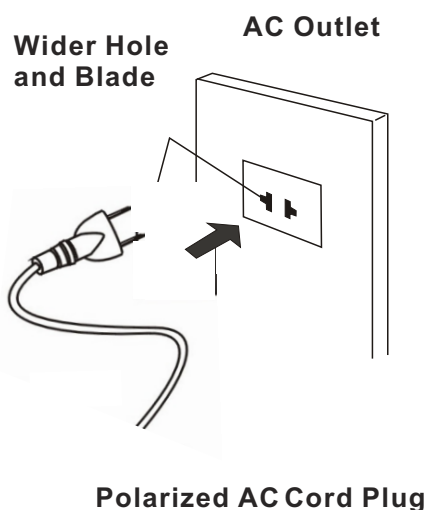

TO USE AC POWER SOURCE

Use the AC polarized line cord provided for operation on AC. Insert the AC cord plug into a standard polarized AC outlet.

Note

- Never connect the AC line cord plug to other than the specified voltage. Use the attached power cord only.
- If the polarized AC cord does not fit into a non-polarized AC outlet, do not attempt to file or cut the blade. It is the user's responsibility to have an electrician replace the obsolete outlet.
- If you cause a static discharge when touching the unit and the unit fails to function, simply unplug the unit from the AC outlet and plug it back in. The unit should return to normal operation.

Removing the table stand and installing a wall mount bracket

HLC26R1

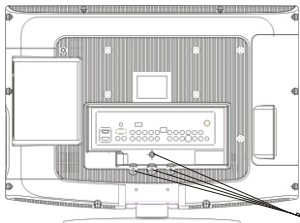

Remove 4X M4 screws securing the stand to the TV, then remove the stand.

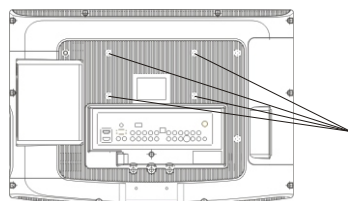

Use 4X M6 screws to secure the wall bracket (not supplied) to the back of your TV.

HLC32R1

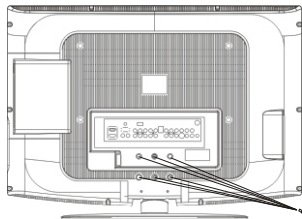

Remove 6X M4 screws securing the stand to the TV, then remove the stand.

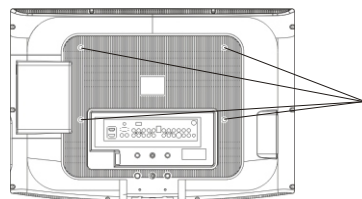

Use 4X M6 screws to secure the wall bracket (not supplied) to the back of your TV.

Operation

In the manual, the OSD (on screen display) may be different from your TV's, because it is just an example to help you with the TV operation.

There are several options you might need to set up in order for your TV to work properly. Read the instructions that follow.

Initial Setup: Set according to the screen display.

Switching On/Off the TV set

1. First, connect power cord correctly.
2. Select the viewing source by using **INPUT** button on the remote control.
3. When finished using the TV, press **POWER** button on the remote control. The TV reverts to standby mode.
4. If you intend to be away on vacation, disconnect the power plug from the wall power outlet.

Note

If the TV is power on, the screen shows information according to the type of input signal. The information will disappear. If there is no signal, "No Signal" will display on the screen.

Choose the Menu Language

When you start using your set for the first time, you must select the language which will be used for displaying menus and indications.

1. Choose **TV** Input and then press **MENU** button.
2. Press **▲/▼** button to select **Function** menu.
3. Press **▶** or **ENTER** button and then use **▲/▼** button to select **Language**.
4. Press **◀/▶** button to select language.
(English, Spanish or French)

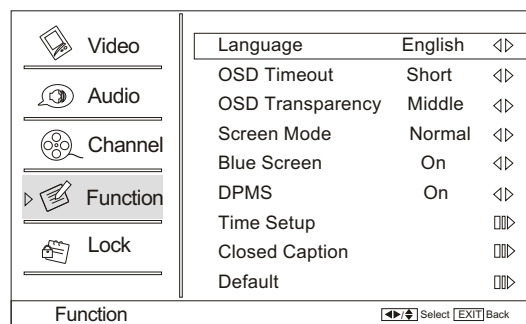

Choose the Input source

Change the picture source so you can watch your TV, VCR, DVD, Cable, or any other devices that are connected to your TV.

1. Press **INPUT** button to enter the Select Source menu and then use **▲/▼** button to select the desired items (TV, Video1, Video2, S-Video, Component1, Component2, VGA, HDMI1, HDMI2, HDMI3, HDMI4).
2. Press **ENTER** button to confirm.

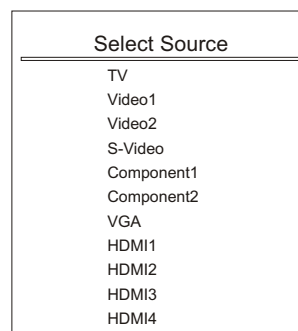

Channel menu

■ This TV set has two methods to set channels, which are respectively Channel Scan, Channel Skip.

■ In this section, how to use the remote control to set channel is explained. You can also use buttons on the TV to set channel.

Note

The Channel menu will be only operated in normal TV mode.

Channel Scan

1. Press **MENU** button and then use **▲/▼** button to select **Channel** menu.
2. Press **▶/ENTER** button to select **Tuner**.
3. Press **◀/▶** button to select **Cable** or **Antenna** mode.
4. Press **▲/▼** button to select **Channel Scan**.
5. Press **▶/ENTER** button to start searching.
6. To cancel searching, press **EXIT** button.

Note

When **Antenna** is selected, the TV will detect antenna signals and will search for antenna TV (NTSC and ATSC) channels available in your local area.

When **Cable** is selected, the TV will detect cable company supplied signals and will search for cable TV (NTSC, QAM modulated) channels available in your Area.

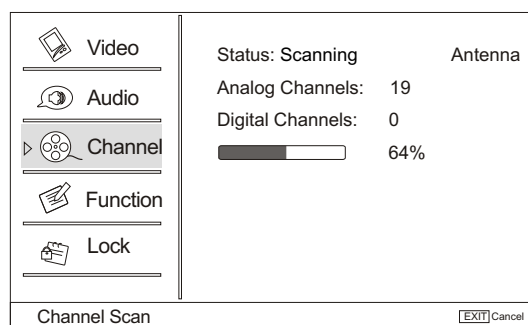
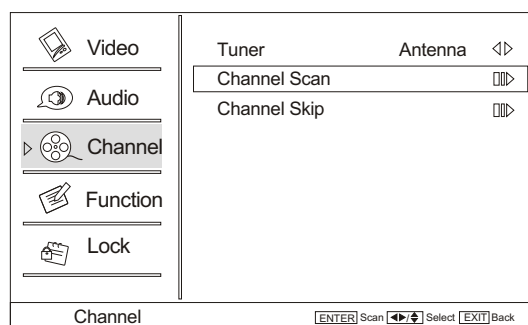

Channel Skip

A skip channel is skipped when using **▲** and **▼** button to browse the channels. A skip channel can be watch by key-in the channel number or select by list.

Default un-scanned analog channels are skip.

Channel with a check icon is a skipped channel.

1. Press **MENU** button and then use **▲/▼** button to select **Channel** menu.
2. Press **▶/ENTER** button and then use **▲/▼** button to select **Channel Skip**.
3. Press **▲/▼** button to select a channel, then press **ENTER** button to toggle between and .

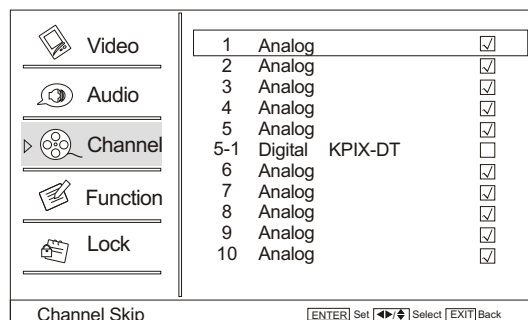
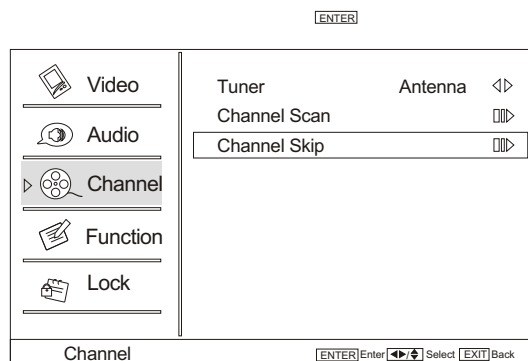

Select the desired program

1. Using **CH+/-** buttons.

■ Press **CH+** button to select a channel number in number increasing direction.

■ Press **CH-** button to select a channel number in number decreasing direction.

Note

If skip is ON on one channel, press **CH+/-** button, the channel will not appear.

2. Also can enter channel number directly, eg: 2-0.

Select the desired sound

Press **VOL-/+** buttons on the remote or the front of the TV set to adjust the volume level. The range is 0~100. When the volume buttons are pressed the volume level is displayed automatically on the TV screen.

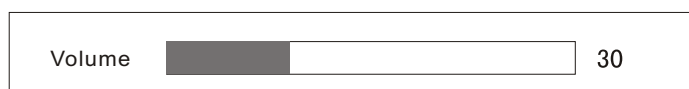

Mute

1. Press **MUTE** button on the remote control and “” type face will display on the screen. At this time, the sound of the TV set is turned off.

2. If you want to recover the sound, press **MUTE** button again or directly press **VOL+** button.



Video menu

The TV menu gives you an overview of the menus you can select.

Note

Depending on the input signal, one or more menu items may not be selectable.

How to select picture mode

The picture mode provides the pre-defined images settings: Standard, Vivid, Custom and Mild .

1. Press **MENU** button and then use **▲/▼** button to select **Video** menu.
2. Press **▶/ENTER** button and then use **▲/▼** button to select **Mode**.
3. Press **◀/▶** button to select the option Standard, Vivid, Custom and Mild.

You can also press **PICTURE** button on the remote control to select the option Standard, Vivid, Custom and Mild.

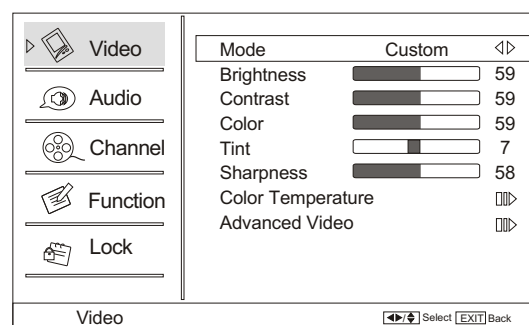

How to customize your own picture status

1. Press **MENU** button and then use **▲/▼** button to select **Video** menu.
2. Press **▶/ENTER** button and then use **▲/▼** button to select the desired items.
3. Press **▶/ENTER** button and then use **◀/▶** button to adjust the setting.

■ Mode

Select the mode of picture(Standard/ Vivid/ Custom/ Mild).

■ Brightness

This will adjust the light output of the complete picture, which will mainly affect the darker areas of the picture.

■ Contrast

This will adjust the intensity of bright parts in the picture but keep the dark parts unchanged.

■ Color

This will adjust the saturation level of the colors to suit your personal preference.

■ Tint

Allows you to select the color mix (Tint) of the picture.

■ Sharpness

This will adjust the sharpness of fine details in the picture.

Note

The picture options can only be adjusted in the CUSTOM mode. The other picture modes are preset.

Video menu

■ Color temperature

This will increase or decrease Warm (red) and Cool (blue) colors to suit personal preferences.

Select Cool to give the white colors a blue tint, Standard to give the white colors a neutral tint, Warm to give the white colors a red tint.

■ Advanced Video

To adjust the picture in advanced: DNR, Black Level Extender, White Peak Limiter, CTI, Flech Tone, Adaptive Luma Control.

■ DNR

To adjust reduce the appearance of digitizing error by the compression: Off, Weak, Medium, Strong, Auto.

■ Black Level Extender

To adjust the ability in the black areas detail of the picture: On and Off.

■ White Peak Limiter

To adjust the ability in the white areas detail of the picture: On and Off.

■ CTI

To adjust the picture for color errors: Off, Weak, Medium and Strong.

■ Flesh Tone

To adjust the flesh color: On and Off.

■ Adaptive Luma Control

To adjust changes in the luminance of the picture: On and Off.

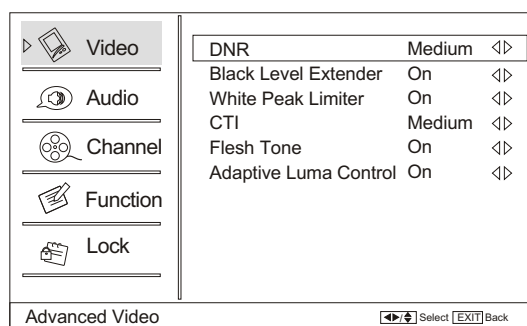

VGA Set

When you select the VGA input, this function is used.

Adjustment for screen Position, Clock, Phase, Setting

Display adjust menu by pressing **INPUT** button then use **▲/▼** button to select the the source of VGA item.

■ Auto sync: Automatically adjust display of the picture (Only available in VGA source).

■ Position : Adjust the screen position.

■ Phase : Adjust the phase of Pixel clock.

■ Clock : Adjust the clock of input signal.

1. Press **MENU** button and then use **▲/▼** button to select **Video** menu.

2. Press **▶/ENTER** button and then use **▲/▼** button to select **VGA**.

3. Press **▶/ENTER** button and then use **◀/▶** button to adjust the setting.

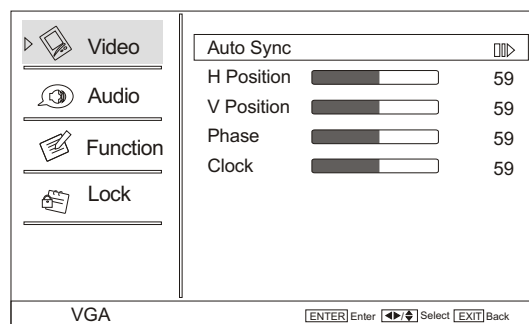
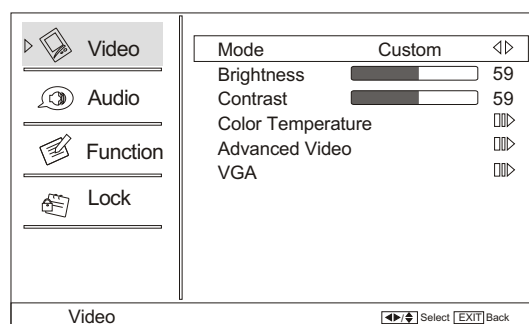

Audio menu

How to select audio mode

1. Press **MENU** button and then use ▲/▼ button to select **Audio** menu.
2. Press ►/ENTER button and then use ▲/▼ button to select **Mode**.
3. Press ►/ENTER button to select the option Off, Concert, Living Room, Hall, Bathroom, Cave, Arena and Church. You can also press **AUDIO** button on the remote control to select the Audio Mode Off, Concert, Living Room, Hall, Bathroom, Cave, Arena and Church.

How to Customize your own audio status

1. Press **MENU** button and then use ▲/▼ button to select **Audio** menu.
2. Press ►/ENTER button and then use ▲/▼ button to select desired items.
3. Press ►/ENTER button and then use ◀/▶ button to adjust the setting.

■ Balance

Adjust to emphasize left or right speaker balance.

■ Bass

Adjust to increase or decrease lower-pitched sounds.

■ Treble

Adjust to increase or decrease higher-pitched sounds.

■ Sound Surround

To turn the simulated surround sound on and off.

■ Mode

To adjust the audio mode: Off, Concert, Living Room, Hall, Bathroom, Cave, Arena and Church.

■ Equalizer

To adjust the equalizer: Off, Rock, Pop, Live, Dance, Techno, Classic and Soft.

■ SPDIF Type

To Adjust the SPDIF output: Off, Dolby Digital and PCM.

■ AVL(Automatic Volume Control)

This will reduce the differences in volume level among broadcasters.

SAP Broadcasts Setup

This TV can receive MTS stereo programs and SAP (Secondary Audio Program) that accompanies the stereo program; if the station transmits an additional sound signal as well as the original one.

When having selected SAP button on the remote control, this TV can only receive the signal when the TV station transmits the proper signals.

Mono sound is automatically received if the broadcast is only in Mono; even though Stereo or SAP has been selected.

Select Mono if you want to listen to mono sound during stereo/SAP broadcasting. Stereo or SAP can be received in a Analog channel.

1. Use **SAP** button to select your desired MTS mode in a analog signal.

Each time you press **SAP** button, Mono, Stereo or SAP appear.

If other languages are available on the digital signal, select them with the SAP button.

2. Press **EXIT** button to save and return to TV viewing.

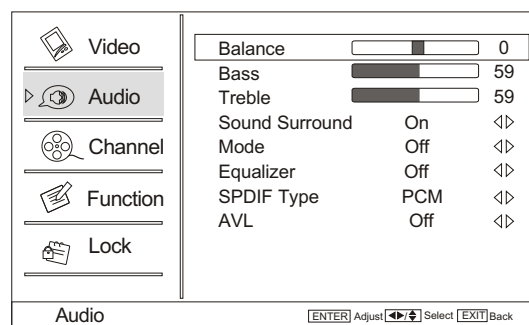

Function menu

Menu Language

When you start using your set for the first time, you must select the language which will be used for displaying menus and indications.

1. Press **MENU** button and then use **▲/▼** button to select **Function** menu.
2. Press **▶/ENTER** button and then use **▲/▼** button to select **Language**.
3. Press **◀/▶** button to select language.
(**English, Spanish or French**)

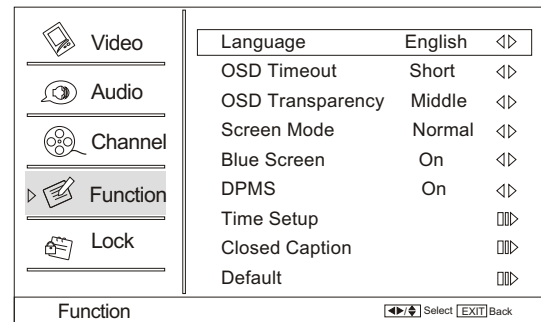

OSD Timeout

1. Press **MENU** button and then use **▲/▼** button to select **Function** menu.
2. Press **▶/ENTER** button and then use **▲/▼** button to select **OSD Timeout**.
3. Press **◀/▶** button to select **Short, Middle or Long**.
(Short is for 5 seconds; Middle is for 10 seconds; Long is for 15 seconds)

OSD Transparency

1. Press **MENU** button and then use **▲/▼** button to select the **Function** menu.
2. Press **▶/ENTER** button and then use **▲/▼** button to select **OSD transparency**.
3. Press **◀/▶** button to select **Low, Middle or High**.

Screen Mode

Lets you choose the way an analog picture with a 4:3 aspect ratio is displayed on your TV with a 16:9 ratio picture format.

Note

If a fixed image is displayed on the screen for a long time, the image may become permanently burned on the screen and remain visible.

1. Press **MENU** button and then use **▲/▼** button to select **Function** menu.
2. Press **▶/ENTER** button and then use **▲/▼** button to select **Screen Mode**.
3. Press **◀/▶** button to select **Normal, Zoom, Wide or Cinema**.

■ Normal

Choose normal when you want to view the picture with 4:3 mode.

■ Zoom

Choose Zoom when you want to view the picture without any alteration. However, the top and bottom portions of the picture will be cropped.

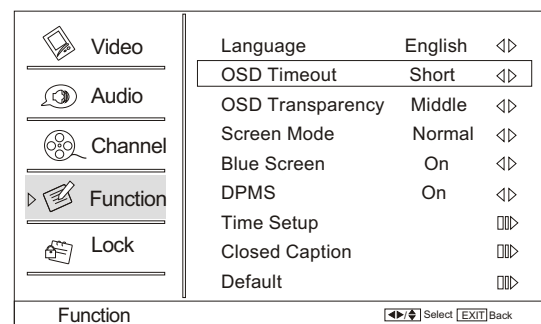

Function menu

■ Wide

Choose wide when you want to adjust the picture horizontally, in a linear proportion to fill the entire screen.

■ Cinema

For letterbox pictures, bars may appear on the top and bottom on some programs.

You can also press **ARC** button on the remote control to select the desired picture format: **Normal**, **Zoom**, **Wide** or **Cinema**.

Blue Screen

1. Press **MENU** button and then use **▲ / ▼** button to select **Function** menu.
2. Press **▶/ENTER** button and then use **▲ / ▼** button to select **Blue Screen**.
3. Press **◀/▶** button to select **On** or **Off**.

DPMS

PC Power Management. To set On, the set will be in standby mode automatically if no signal in 2 minutes; if signal input, the set will be on again automatically.

Note: DPMS is useful only in VGA source.

Time zone setting

This function allows you to select your local time zone. Broadcasted time information will correct the clock display for your local time.

1. Press **MENU** button and then use **▲ / ▼** button to select **Function** menu.
2. Press **▶/ENTER** button and then use **▲ / ▼** button to select **Time Setup**.
3. Press **▶/ENTER** button and then use **▲ / ▼** button to select **Time Zone**.
4. Press **◀/▶** button to select your viewing area time zone: **Eastern, Central, Mountain, Pacific, Alaska** or **Hawaii**.

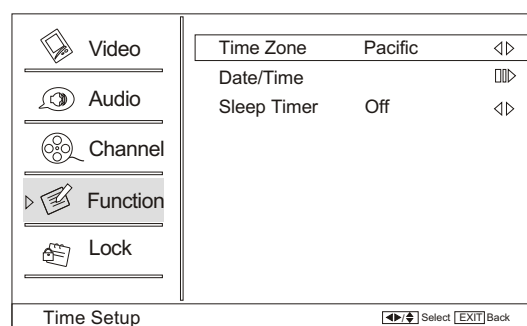

Date /Time setting

Setting the clock is necessary in order to use the various timer features of the TV. Also, you can check the time while watching the TV.

1. Press **MENU** button and then use **▲ / ▼** button to select **Function** menu.
2. Press **▶/ENTER** button and then use **▲ / ▼** button to select **Time Setup**.
3. Press **▶/ENTER** button and then use **▲ / ▼** button to select **Date/Time**.
4. Press **▶/ENTER** button and then use **◀/▶** button to select **On** or **Off**.

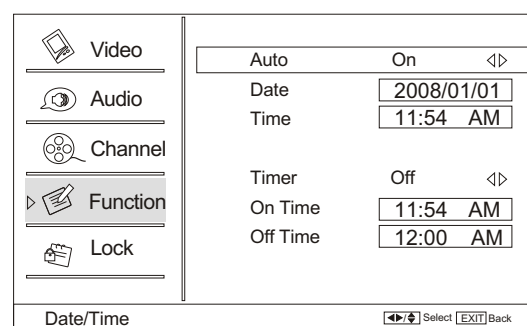

Function menu

Sleep Timer setting

The sleep timer automatically shuts off the TV after a preset time (from 5 to 240 minutes).

1. Press **MENU** button and then use **▲/▼** button to select **Function** menu.
2. Press **►/ENTER** button and then use **▲/▼** button to select **Time Setup**
3. Press **►/ENTER** button and then use **▲/▼** button to select **Sleep Timer**.
4. Press **◀/▶** button to select the number of minutes. Select **Off, 5Min, 10Min, 15Min, 30Min, 45Min, 60Min, 90Min, 120Min, 180Min** or **240Min**.

The time begins to count down from the number of minutes selected.

5. To cancel the set sleep timer: Press **►** button to select **Off**.

You can also press **SLEEP** button to select quickly the sleep timer.

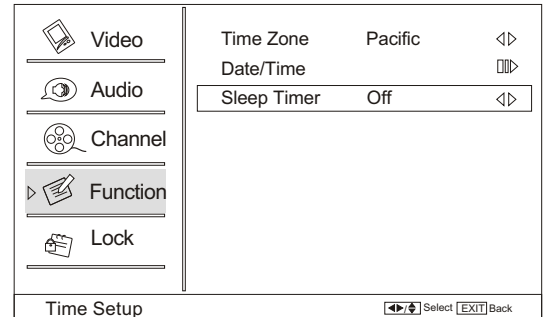

DTV Caption Style (In DTV mode)

This allows you to modify how digital captions are displayed on your TV. Select from the following options to change the visual characteristics of your TV's digital captioning.

Customize the DTV/CADTV captions that appear on your screen.

1. Press **MENU** button and then use **▲/▼** button to select **Function** menu.
2. Press **►/ENTER** button and then use **▲/▼** button to select **Closed Caption**.
3. Press **►/ENTER** button and then use **▲/▼** button to select **DTV Caption Style**.
4. Press **►/ENTER** button and then use **▲/▼** button to select the Style, Size, etc., press **◀/▶** button to customize to your preference.

■ Style

Select this option to select the font style of caption display according to your own preference.

Press **◀/▶** button to select **Default** or **Custom**.

■ Size

Select this option to select the size of caption display according to your own preference.

Press **◀/▶** button to select **Small**, **Normal** or **Large**.

■ Text color

Select this option to select the text color or the opacity of the text box of caption display according to your own preference.

Select a color and one of the opacity options.

■ Text Opacity

Specify the opacity for the text color.

■ BG Color

Select a background color.

■ BG Opacity

Select the opacity for the background color.

■ Window Color

Select a window color.

■ Window Opacity

Select the opacity for the window color.

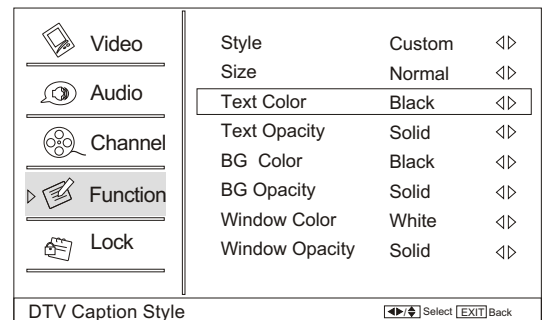
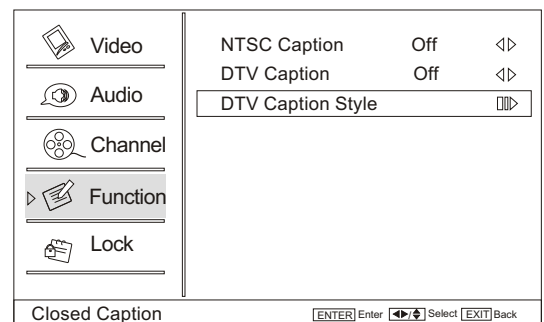
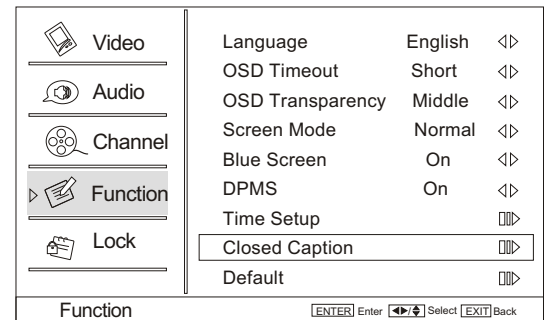

Lock Menu

Parental Control can be used to block specific channels, ratings and other viewing sources.

The parental control function is used to block program viewing based on the ratings sent by the broadcasting station. The default setting is to allow all programs to be viewed. Viewing can be blocked by choosing the type of the program and the categories.

Parental Control rating and categories

Rating guidelines are provided by broadcasting stations. Most television programs and television movies can be blocked by TV Rating or Individual Categories. Movies that have been shown at the theaters or direct-to-video movies use the Movie Rating System (MPAA) only.

Ratings for Television programs :

Parental Guide

- TV-Y (All children)
- TV-Y7 (Children 7 years older)
- TV-G (General audience)
- TV-PG (Parental guidance suggested)
- TV-14 (Parents strongly cautioned)
- TV-MA (Mature audience only)

Ratings for Movies previously shown in theaters:

MPAA Rating :

- G (General audience)
- PG (Parental guidance suggested)
- PG-13 (Parents strongly cautioned)
- R (Restricted)
- NC-17 (No one 17 and under admitted)
- X (Adult only)

If you set PG-13: G and PG movies will be available, PG-13, R, NC-17 and X will be blocked.

CA Eng Rating

- C Children
- C8+ Children eight years and older
- G General Programming, suitable for all audiences
- PG Parental Guidance
- 14+ Viewers 14 years and older
- 18+ Adult Programming

CA Fren Rating

- G General
- 8 ans+ Not recommended for young children
- 13 ans+ Programming may not be suitable for children under the age of 13
- 16 ans+ Programming is not suitable for children under the age of 16
- 18 ans+ Programming restricted to adults

TV Rating :

- A (Age) (applies to TV-Y, TV-Y7, TV-G, TV-PG, TV-14, TV-MA)
- D (Dialogue - sexual dialogue) (applies to TV-PG, TV-14)
- L (Language - adult language) (applies to TV-PG, TV-14, TV-MA)
- S (Sex - sexual situations) (applies to TV-PG, TV-14, TV-MA)
- V (Violence) (applies to TV-PG, TV-14, TV-MA)
- FV (Fantasy Violence) (applies to TV-Y7)

Lock Menu

Lock setup

Set up blocking schemes to block specific channels, ratings, and external viewing sources.

A password is required to gain access to this menu.

1. Press **MENU** button and then use **▲/▼** button to select **Lock** menu. Then, press **▶** button.

The TV is set up with the initial password “0-0-0-0” and security default password is 9-4-4-3.

2. Use **▲/▼** button to select the desired items, and press **▶** or **ENTER** button to enter the next menu. Once the option is selected, change the settings to your preference.

Password

Change the password by inputting a new password twice.

Channel Block

1. Press **MENU** button and then use **▲/▼** button to select **Lock** menu.
2. Press **▶/ENTER** button and then use **▲/▼** button to select **Channel Block**.
3. Press **▲/▼** button to select the item, Press **ENTER** button to set.

Parental Lock

1. Press **▲/▼** button to select **Parental Lock** item.
2. Press **◀/▶** button to select **On** or **Off**.

Note

If the Parental Lock is setting as Off, the change of the Parental Guide ,MPAARating ,CAEng Rating and CA Fren Rating will be no useful.

Parental Guide

Note

The Parental control will automatically block certain categories that are “more restrictive” . For example, if you block “TV-Y” category, then all the categories in the “young adult” group will be blocked (TV-Y, TV-Y7, TV-G, TV-PG, TV-14 and TV-MA).

The sub-ratings (D, L, S, V, FV) work together similarly.

How to set the D, L, S, V and FV sub-ratings.

First, press **▲/▼** button select one of these Ratings: TV-Y, TV-Y7, TV-G, TV-PG, TV-14, or TV-MA, and press **◀/▶** button.

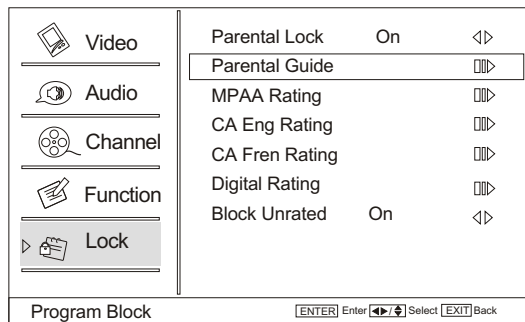
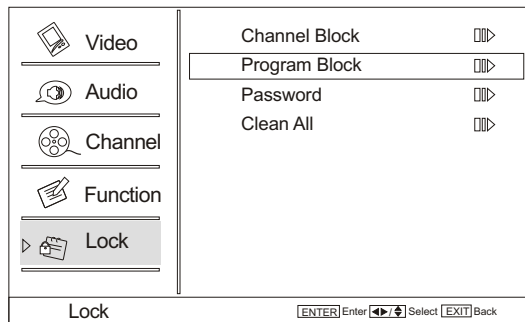
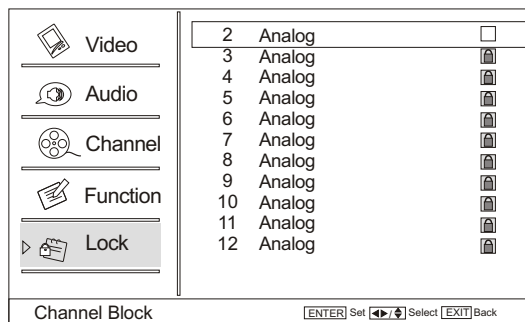
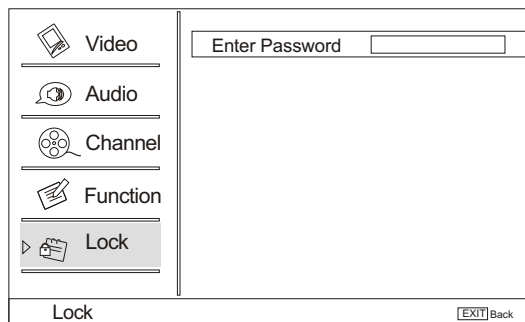

Lock Menu

Lock setup

A symbol “□” will be displayed for each sub-rating. While “□” is selected, press **ENTER** button to go to a sub rating. To select a different Rating, press ▲/▼ buttons and then repeat the process.

Note

The V-chip will automatically block certain categories that are “More restrictive”. For example, if you block “🔒” sub-rating in TV-PG, then the “🔒” sub-ratings in TV-14 and TV-MA will automatically be blocked.

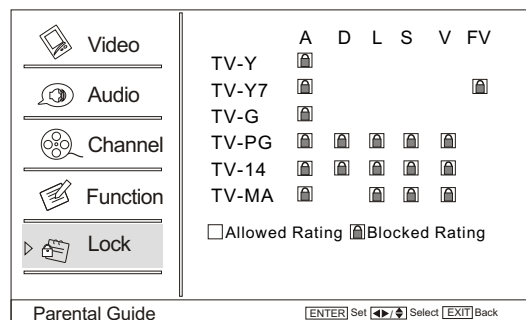

MPAA Rating

Blocks movies according to the movie ratings limits specified, so children cannot view certain movies. You can set the ratings limit by blocking out all the movies with the ratings above a specified level. Keep in mind that the movie ratings limit only applies to movies shown on TV, not TV programs, such as soap operas.

1. Press ▲/▼ button to select **MPAA Rating** item.
2. Press ▶/ENTER button and then use ▲/▼ button to select the rating.
3. Press **ENTER** button to set block or unblock.

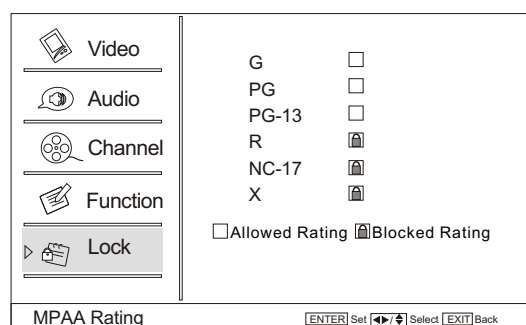

CA Eng Rating

Canadian English Language Rating

1. Press ▲/▼ button to select **CA Eng Rating** item.
2. Press ▶/ENTER button and then use ▲/▼ button to select the rating.
3. Press **ENTER** button to confirm.

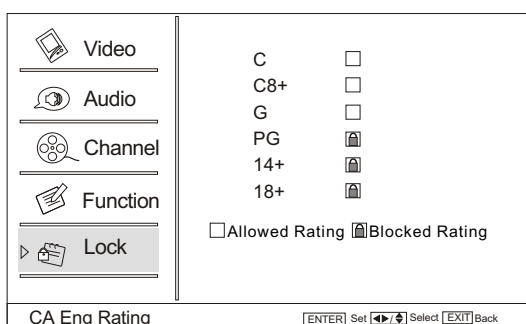

CA Fren Rating

Canadian French Language Rating

1. Press ▲/▼ button to select **CA Fren Rating** item.
2. Press ▶/ENTER button and then use ▲/▼ button to select the rating.
3. Press **ENTER** button to confirm.

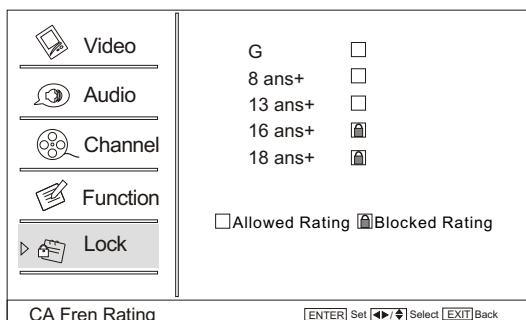

Other Functions

Brief Info

Brief Info shows the present screen information.
 Press **DISPLAY** button to show the Brief Info on the screen.
 Press **DISPLAY** button or **EXIT** button to exit.

Function:

- Show the present screen information.
- Press **DISPLAY** button or **EXIT** button to exit.

- A: Video resolution
- B: Program name
- C: Program rating categories
- D: program showtime
- E: Program title
- F: Channel Lable
- G: Tuner mode
- H: Program details



Using the Guide

The guide allows you to select the channels from a channel list.
 The guide allows provides information about the current program being shown on each channel(if information is available from the station).

Note

Program information in the guide is provided by the broadcasters. As a result, it may sometimes include only the channel number, without a program title or description.

- A: Program title
- B: program options
- C: program showtime
- D: Program details
- E: Program rating categories

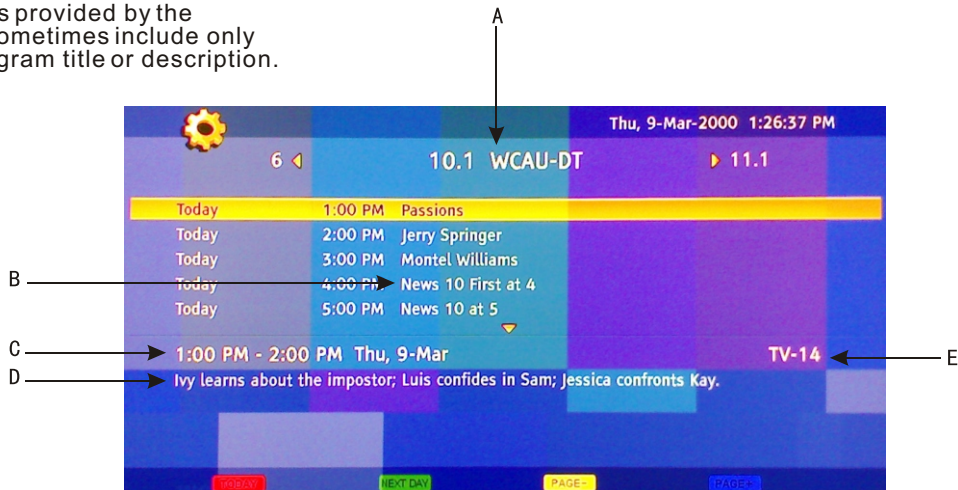

Other Functions

Quick program view

Press to jumpback and forth between two channels. The TV alternates between the current channel and the last channel that was selected.

1. Suppose the channel number you used just now is 8 and the channel number you are using is 18 (as shown in the figure).
2. If you want to return to the last watched program channel 8, you can simply press **RECALL** button.
3. If you want to return to channel 18, press the button again.

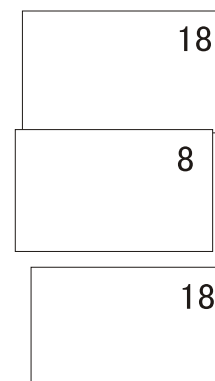

CC (Closed Caption Display)

Closed Captions

Closed captioning is a process which converts the audio portion of a television program into written words which then appear as subtitles on the television screen. Closed captions allow viewers to read the dialogue and narration of television programs.

Using Closed Captions

Captions are the subtitles of the dialogue and narration of television programs. For prerecorded programs, program dialogue can be arranged into captions in advance. It's possible to caption a live program by using a process called real-time captioning, which creates captions instantly. Real-time captioning is normally done by professional reporters using a machine shorthand system and computer for translation into English. Captioning is an effective system for the hearing-impaired, and it can also aid in teaching language skills.

In ATV mode CCD function allows you to configure the way you choose to view the digital captioning (Off, CC1, CC2, CC3, CC4, Text1, Text2, Text3 or Text4).

■ CAPTION

The term for the words that scroll across the bottom of the TV screen; usually the audio portion of the program provided for the hearing impaired.

■ TEXT

The term for the words that appear in a large black frame and almost cover the entire screen; usually messages provided by the broadcaster.

In DTV mode allows you to configure the way you choose to view the digital captioning (Off, service1, service2, service3, service4, service5 or service6).

Select one of the digital service channels made available by the caption provider.

There are 6 standard services. Service 1 is designated as the Primary Caption Service. This service contains the verbatim, or near-verbatim captions for the primary language being spoken in the accompanying program audio. Service 2 is designated as the Secondary Language Service. This service contains captions in a secondary language which are translations of the captions in the primary Caption Service. The other service subchannels are not pre-assigned. It is up to the discretion of the individual caption provider to utilize the remaining service channels.

Note

The captions do not always use correct spelling and grammar. Not all TV programs and product commercials are made for broadcast with Closed Caption information included. Refer to your area's TV program listings for the TV channels and times of Closed Caption shows. The captioned programs are usually noted in the TV listings with service marks such as "CC".

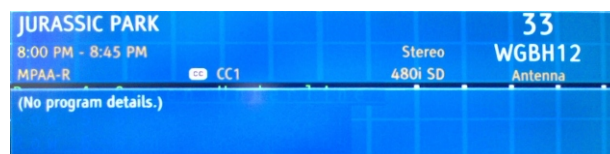

USB Input

1. Supporting media and file format: Digital pictures (.JPG) and digital music (.MP3) files

Due to differences in the file code and file mode, it is possible that some files cannot be read.

2. Before starting operation, verify USB storage device is of FAT32 and FAT file system format. At present, this television does not support NTFS and the file systems of other format.

3. External card reader supports most digital cards available in the market. Readable digital cards are classified according to the property of card readers and can be connected to mobile hard disks (working voltage 5.0V, working current not over 500mA).

4. The television operation may be halted due to excessive rate of information code errors. In such case, restart the system. Please note - there are many nonstandard USB mobile devices in the market. If a nonstandard device is used then an identification problem may occur.

To play pictures

1. Press USB button on the remote to enter stream media system. The system start up takes about 3 seconds. Then insert the USB drive in the USB input.

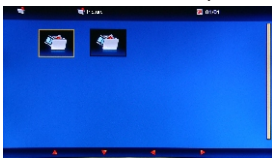

2. Press ◀/▶ button to select Picture folder. Press ENTER to enter.

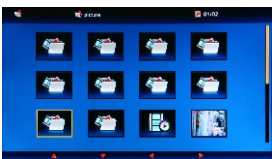

3. Press ▲/▼/◀/▶ button to select desired picture, and then press ENTER button to enter the play interface.

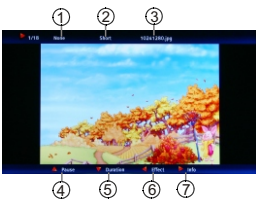

- 1. Play mode: None/Dissolve/Wipe right/Wipe left/Wipe up/Wipe down/Box in/Box out
- 2. Play time: Short/Medium/Long; 3. File name 4. Pause/Play
- 5. Duration/Rotate 6. Effect 7. Information

4. Press the button on the remote control to select the adjusted item, press ENTER button to confirm.

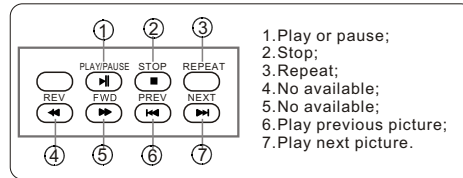

- 1. Play or pause;
- 2. Stop;
- 3. Repeat;
- 4. No available;
- 5. No available;
- 6. Play previous picture;
- 7. Play next picture.

5. Press EXIT button to return to the previous menu. Press USB button to exit the USB mode.

Note: you may play the pictures among selected.

To play music

1. Press ◀/▶ button to select Music folder. Press ENTER to enter.

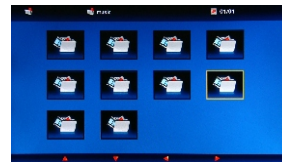

2. Press ▲/▼/◀/▶ button to select desired music, and then press ENTER button to enter the play interface.

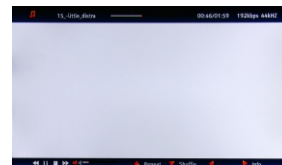

3. Press the button on the remote control to select the adjusted item, press ENTER button to confirm.

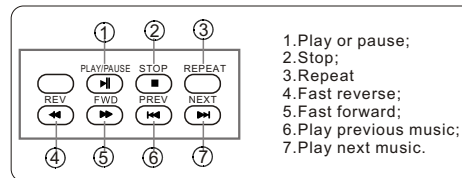

- 1. Play or pause;
- 2. Stop;
- 3. Repeat;
- 4. Fast reverse;
- 5. Fast forward;
- 6. Play previous music;
- 7. Play next music.

4. Press EXIT button to return to the previous menu. Press USB button to exit the USB mode.

Note: You may play the music among selected.

USB Input

To play pictures and music together

Insert USB drive with music and picture files in to the USB input and select the pictures to be played. Then select the Music folder and choose the MP3 files to be played. Then select the Music folder and choose the MP3 files to be played. Please note as some files must be read while music is being played, the speed of picture operation response might be affected.

1. Press ◀/▶ button to select Music folder.
Press ENTER to enter.

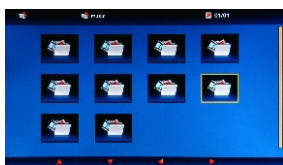

2. Press ▲/▼/◀/▶ button to select desired music, and then press ENTER button to enter the play interface.

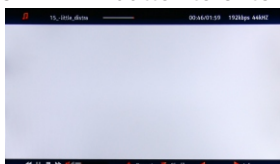

3. Press USB button to turn to the main menu. And then press ◀/▶ button to select Picture folder.
Press ENTER to enter.

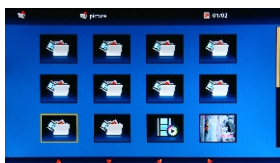

4. Press ▲/▼/◀/▶ button to select desired picture, and then press ENTER button to enter the play interface.

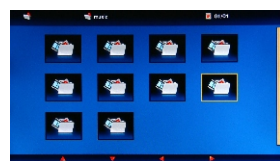

5. Press USB button to exit USB mode.

Note: Do not remove USB device from the TV until you have exited the USB mode otherwise you may damage the USB device.

DVD Operation

Basic Playback

Preparations

Press DVD button on the remote control to enter the DVD status.

Note: Do not insert a disc until the DVD input states open.

Basic playback

1. Place the DVD in the disc slot. The disc will be loaded automatically after one to two seconds then the DVD player reads the DVD and displays the opening menu (If there is no disc placed in DVD mode, OPEN will display on the screen all the times)

Do not place a disc that is unplayable in this DVD player. Some discs do not start automatically. Press PLAY/PAUSE to start playback.

2. Some discs may start playback with a menu. Use the cursor buttons on the remote control to select menu options and press PLAY/PAUSE to start. You may also press the digit buttons to select a menu option directly. Many DVDs will not allow this during start-up.

Stop playback

1. Press STOP button to go to stop mode, the TV screen will show the start logo. With some discs, such as DVD or CDs, the player can resume playback from the point where it was stopped.

2. Press PLAY/PAUSE to resume playback from the location where the playback was stopped.

3. Press STOP twice to stop completely.

Previous and Next

During Playing, pressing the PREV button will restart the last chapter and skip chapters backwards with each subsequent press until the start of the disc is reached.

Each press of NEXT button during playing will skip the current chapter and play the next one.

Fast forward and Fast reverse

1. Press FWD to fast forward through the disc. Each time the FWD button is pressed, the fast forward motion speed changes.

2. Press PLAY/PAUSE to resume normal playback.

3. Press REV to fast reverse through the disc.

Each time the REV button is pressed, the fast reverse motion speed changes.

4. Press PLAY/PAUSE to resume normal playback.

Advanced Playback

IMPORTANT NOTE:

All described functions are for dvd discs.

If you play other disc Formats the operation and on screen display will be different.

SUBTITLE

Press " SUBTITLE ", the screen will display "SUBTI-TLE 01/XX XXXXX", "01" indicates the ordinal number of this language; "XX" indicates total number of language; "XXXXXX" indicates the language of country. (The number of language depends on disc.)

This function can select up to 32 languages display-ed on screen.

REPEAT

Press " REPEAT " and Chapter repeat will be displayed on screen, the second press will display

Title repeat, the third press will display All repeat, the fourth press will cancel this function.

ANGLE

When enjoying sports, concert or theatre, press this key to watch same actions in different angles. (Valid for discs possessing this function. Using a disc recorded in multi-angle you can view the scene from different angles, for example, front, side, whole view and exterior scene).

D.MENU

Press this key to display the root menu, select items according to your preference. (This function will work on a DVD with a multi-layer menu.)

D.CALL

Pressing this key will cycle through "Title Elapsed", "Title Remain", "Chapter Elapsed", "Chapter Remain" and "Display off".

PROGRAM

When playing discs, press "PROGRAM" to enter program mode. Press the digit buttons to select the program number that you want. When finished move the cursor to select "START". Press PLAY/ENTER to confirm. This will start the program playback.

SEARCH

Press "SEARCH" once to display the search menu. Press the button again to select. Press the program number buttons to input the item you require. Press ENTER to confirm.

D.AUDIO

Press this key can change the mode of audio.

such as: Audio 1/2: AC 3 2 CH English

Audio 2/2: AC 3 5.1 CH English

Press this button to cycle between Mono Left, Mono Right, Mix-Mono and Stereo.

Note: When press this button continuously, you must allow a 3 second interval between selections.

DVD Operation

Special Function Playback

JPEG DISC PLAYBACK

When a disc containing standard JPEG picture files is inserted into the player, a navigation menu will be displayed automatically. Use the ▲/▼ cursor buttons to select a file then press ENTER. The slide show will commence.

Press PREV or NEXT to move between pictures. Press pause to stop on the current picture. Press ENTER to resume normal playing.

A JPEG disc contains JPEG (.jpg) format picture information that can be decoded by a micro-computer software and displayed through the video output interface or on the television screen.

This function has many applications. For example one can save files from a scanner or digital camera in the JPEG format, record these on a CD-R disc and present them to an audience through this player.

The JPEG format is a convenient method to store images in a small amount of memory space, and is ideal for archiving information.

SCREEN SAVER FUNCTION

This unit employs a screen saver mode to help protect the tube during static video pictures. This can be turned off on the GENERAL SETUP PAGE.

DVD System Setup

General Setup Process

1. Press SETUP button, the general set up page will be displayed press twice the preference page will be displayed.
 2. Press ▲/▼ to select, the item, then press ► to enter the submenu.
 3. Press ▲/▼ to select then press ENTER to confirm.
 4. Press SETUP repeatedly to exit the set-up menus.
- NOTE: Preference page will be displayed when there is no disc in the unit. To access this page, press SETUP button twice.

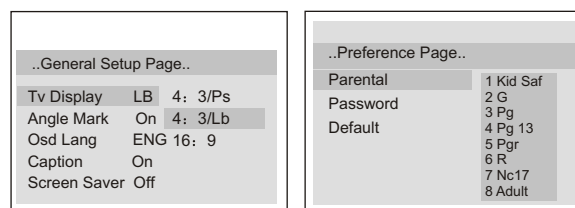

General Setup Page

ASPECT RATIO DESCRIPTION

When using the DVD with the internal TV, select 4: 3/LB.

The following information applies only when the DVD output is connected to an external TV.

●4:3/PS (PS = Pan and Scan)

You may select if you have a normal aspect ratio (4:3) TV, although the NORMAL/LB (letter box) is a more common choice. In PS mode, wide screen material will fill the screen, but at the expense of chopping off extreme left and right edges of the original film picture. For this feature to work, the disc must be specially coded. Such discs are uncommon.

●4:3/LB (LB = Letter Box)

You may select this if you have a normal aspect ratio (4:3) TV. Wide screen material will be shown in pure unaltered form, allowing the entire picture area of the original film to be viewed without any side cropping. Black bars will appear above and below the picture.

●16:9

You may select this if you have a wide screen (16:9) TV. Black bars may still appear above and below the picture even if using a wide screen TV. This is because some film directors prefer to use ultra wide screen aspect ratios e.g. 2.35:1. This will normally be indicated on the DVD packaging.

DVD Operation

DVD System Setup

General Setup Page

ANGLE MARK: Users can select a particular camera angle when playing a DVD which offers multiple angles. This item allows you to set Angle Mark ON or OFF.

On Screen Display (OSD) Language:
Users can select on-screen display language.

CAPTION:
This function allows you to display or hide the caption.

SCREEN SAVER:
If the screen saver is on, then there will be an animated picture of DVD on the screen whenever the DVD player is idle for more than 3 minutes .

Preference Page

The Preference Page is only available when there is no disc in the player.

PARENTAL:
The parental control function works in conjunction with the different censorship classes assigned to DVDs. These classes help to control the types of DVDs that the family watches, There are up to 8 censorship classes for DVDs.

Note:
1 To change this setting you must enter your password. (Initial password is 1234)
2 When set to OFF, all discs may be viewed.

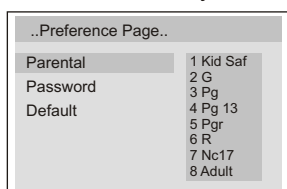

PASSWORD CHANGE:
You can change your password by entering 4 digits. You must confirm the 4 digits before the new password can be accepted.

Note:
If you forget your password or a password is accidentally set enter 1369 as the password. This will enable you to regain control.

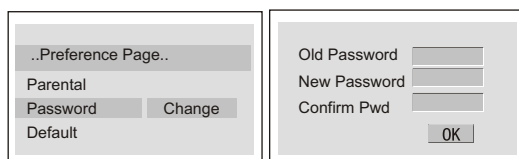

DEFAULT:
Resets all settings (except password and parental lock status) for this DVD player back to the manufacturers original settings. Press ENTER to perform the reset.

Note:
Some functions may not be available depending on the type of disc.

Playable Discs

The following discs can be played:

DISCS	LABEL	CONTENTS	DIMENSION
DVD VIDEO		Audio +Video (moving picture)	12cm
AUDIO CD		Audio	12cm
JPEG		Video(picture)	12cm
KODAK CD		Video(picture)	12cm
CD-R	CD•R	Audio or Video (moving picture)	12cm
CD-RW	CD-RW	Audio or Video (moving picture)	12cm
CD+G	CD+G	Audio(picture)	12cm

Support discs: DVD, CD-R, CD-RW, HDCD, JPEG, CD+G, Kodak CD , W MA.

- You cannot play discs other than those listed above.
- You cannot play non-standardized discs, even if they may be labeled as above.
- The performance of CD-R or CD-RW disc is depend on the way of disc was burned. In a few cases, their performance may not be consistant or may not even operate at all.

This DVD Player is designed and manufactured according to the Region Management Information that is recorded on a DVD disc. If the Region number described on the DVD disc does not correspond to the Region number of this DVD Player, this DVD player will not play that disc.

This Region number of this DVD Player is .

DVD Operation

Discs Protection and DVD Characteristics

ON HANDLING DISCS

- Do not touch the playback side of the disc.
- Do not attach paper or tape to disc.

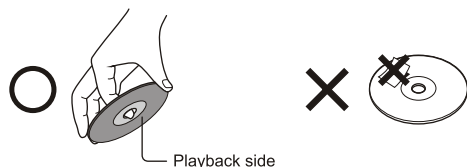

ON CLEANING DISCS

- Fingerprints and dust on the disc cause picture and sound deterioration. Wipe the disc from the centre outwards with a soft cloth. Always keep the disc clean.
- If you can not wipe off the dust with a soft cloth, wipe the disc lightly with a slightly moistened soft cloth and finish with a dry cloth.
- Do not use any type of solvent such as thinner, benzene, commercially available cleaners or anti-static spray for vinyl Lps. It may damage the disc.



ON STORING DISCS

- Do not store discs in a place subject to direct sunlight or near heat source.
- Do not store discs in place subject to moisture and dust such as a bathroom or near a humidifier.
- Store discs vertically in a case. Stacking or placing object on discs outside of their case may cause warping.

STRUCTURE OF DISC CONTENTS

Normally, DVD discs are divided into titles, and the titles are sub-divided into chapters. Audio CD are divided into tracks.

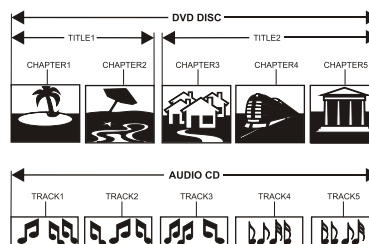

Each title, chapter, or track is assigned a number, which is called title number, chapter number or track number respectively.

There may be discs that do not have these number.

Compare DVD disc with other discs:

	DVD				LD	SVCD	VCD	CD
Encode method	Digital/MPEGII				Analog	Digital	Digital/MPEGII	Digital
Capacity	Single-side single-layer 4.7G	Double-side single-layer 8.5G	Single-side double-layer 9.4G	Double-side double-layer 17G	/	650MB	650MB	650MB
Playing Time	133 minutes	242 minutes	266 minutes	484 minutes	Single-side 60 minutes double-side 120 minutes	45 minutes	74 minutes	74 minutes
Disc diameter	12cm				30cm/20cm	12cm	12cm	12cm
Horizontal resolution	More than 500 line				No more than 430 line	No more than 350 line	No more than 250 line	/
Picture proportion	Multiple kinds				One kind	One kind	One kind	/
Subtitle	32 kinds				16 kinds at most	4 kinds	/	/
Language	8 kinds				4 kinds at most	4 kinds at most	2 kinds	2 kinds
Sound quality	48KHz, 96KHz/ 6, 20, 24bit				44.1KHz/ 16bit	44.1KHz/ 16bit	44.1KHz/ 16bit	44.1KHz/ 16bit

Maintenance

Early malfunctions can be prevented. Careful and regular cleaning can extend the amount of time you will have your new TV. Be sure to turn the power off and unplug the power cord before you begin any cleaning.

Cleaning the Screen

1. Here's a great way to keep the dust off your screen for a while. Wet a soft cloth in a mixture of lukewarm water and a little fabric softener or dish washing detergent. Wring the cloth until it's almost dry, and then use it to wipe the screen.
2. Make sure the excess water is off the screen, and then let it air-dry before you turn on your TV.

Cleaning the Cabinet

To remove dirt or dust, wipe the cabinet with a soft, dry, lint-free cloth. Please be sure not to use a wet cloth.

Extended Absence

If you expect to leave your TV dormant for a long time (such as a vacation), it's a good idea to unplug the power cord to protect against possible damage from lightning or power surges.

Product Specification

Resolution	HLC26R1/HLC32R1
	1366X768(Dot)
Power requirement	120V~ , 60Hz
Stand-by Consumption	less than 1W
Color system	NTSC, ATSC, Clear QAM
External Antenna Impedance	75 ohm
Color	16,770,000(256 steps of each R, G and B)
Operating Temperature Range	32~104°F(0~40°C)
Operating Humidity Range	Less than 80%
Maximum Elevation	6561 feet (2000m)

MODEL	Dimensen(WXDXH) Unit:inches/mm (Including stand)	Weight(pounds/kg)
HLC26R1	26.1X8.0 X19.7inches 662X202X501 mm	30.9/14.0
HLC32R1	31.3X9.2 X22.9inches 796X233X582 mm	38.6/17.5

■ The specifications shown above may be changed without prior notice for quality improvement.

Troubleshooting

For the sake of time and cost, it is strongly recommended that you check out the problem by yourself according to the instructions listed hereunder before contacting the after-sales service for technical assistance.

No picture, no sound	Verify if the television is properly plugged. Verify if the television is properly supplied power. Verify if electricity is available.
Blank screen	Verify if correct signals are input. Press INPUT button to change signal input to TV input. Restart the television if power supply is interrupted.
No sound	Press Mute button and verify if Mute mode is set. Switch to other channel and verify if the same problem happens. Press VOL+ button to see if the problem can be solved.
Poor sound	Verify if sound system is correct. Refer to Page 22 for adjustments.
No picture in some channel	Verify if correct channel is selected. Adjust the antenna. Make adjustments by Fine Tune and Manual Scan.
No color for some channel program (black and white)	Verify if the same problem exists in other channels. Check out of picture and sound systems. Refer to relative instructions in the Manual for color adjust.
Spots with some or all pictures	Verify if the antenna is correctly connected. Verify if the antenna is in good condition. Make fine adjustment of channel.
Horizontal/vertical bars or picture shaking	Check for local interference such as an electrical appliance or power tool.
Television out of control	Disconnect the television from power supply and, 10 seconds later, connect the television to the power supply. If the problem still exists, contact authorized after-sales service for technical assistance.

Note: Do not leave the television with static picture in an extended period as the image may become permanently burned.

Note: Production of the LCD screen requires high and precision technologies. However, there might be some dark or bright (red, blue or green) spots, or some anomalistic stripes or spots. This is not defect. If the TV set is used in an area 2,400 meters above the sea level where the air pressure is below 750hpa, the picture on the LCD screen may be affected and a muffled sound might be produced. These phenomena might happen in the area 1,500 meters above the sea level. This is resulted from difference between air pressures inside and outside the display. This is not a defect covered by the limited warranty.

Warranty

This Haier brand product, when shipped in its original container, will be free from defective workmanship and materials, and agrees that it will, at its option, either repair the defect or replace the defective product with a new or re-manufactured equivalent at no charge to the purchaser, for parts or labor for the periods set forth below:

This warranty does not apply to the appearance of the product or the exterior of the product, which has been damaged or defaced, altered or modified in design or construction. It does not apply to the additional excluded items set forth below:

The warranty commences on the date the item was purchased and the original purchase receipt must be presented to the authorized service center before warranty repairs are rendered.

The limited warranty described herein is in addition to whatever implied warranties may be granted to purchasers by law. ALL IMPLIED WARRANTIES INCLUDING THE WARRANTIES OF MERCHANTABILITY AND FITNESS FOR USE ARE LIMITED TO THE PERIOD(S) FROM THE DATE OF PURCHASE SET FORTH BELOW. Some states do not allow limitations on how long an implied warranty lasts, so the above limitation may not apply to you.

Neither the sales personnel of the seller nor any other person is authorized to make any warranties other than those described herein, or to extend the duration of any warranties beyond the time period described herein on behalf of Haier.

The warranties described herein shall be the sole and exclusive warranties granted by Haier and shall be the sole and exclusive remedy available to the purchaser. Correction of defects in the manner and for the period of time described herein, shall constitute complete fulfillment of all abilities and

Responsibility of Haier to the purchaser with respect to the product, and shall constitute full satisfaction of all claims, whether based on contract, negligence, strict liability or otherwise. In no event shall Haier be liable, or in any way responsible for any damages or defects in the product which were caused by repairs or attempted repairs performed by anyone other than an authorized service center or dealer; nor shall Haier be liable, or in any way responsible for incidental or consequential economic or property damage. Some states do not allow the exclusion of incidental or consequential damages, so that above exclusion may not apply to you.

THIS WARRANTY GIVES YOU SPECIFIC LEGAL RIGHTS. YOU MAY ALSO HAVE OTHER RIGHTS WHICH VARY FROM STATE TO STATE.

Warranty period for this product: one year parts and labor.

Additional items excluded from warranty coverage: non-rechargeable batteries.

Where to obtain service: For the location of the nearest Haier authorized service center or to obtain product literature, accessories, supplies or customer assistance, please call 1-877-337-3639.

What to do to obtain service: ship or carry in your product to an authorized service dealer or center. Be sure to have proof of purchase. If you ship the product, be sure it is packaged carefully.

Haier America
New York, NY 10018

Haier®